



User's Manual

Window type Air Conditioner
(Inverter Cooling)

RC-S7HR

RC-S9HR

RC-S12HR

RC-S18HR

RC-S24HR



R32

Thank you for choosing our product.
Please read this User's Manual carefully before operation
and retain it for reference.

CONTENTS

Thank you for choosing the air conditioner. Please read this user's manual carefully before operating the unit and keep it for consultation.

Structure mechanism and Installation

The Refrigerant	1
Specialist's Manual	2
Precautions	8
Function	9
Power requirement Installation	10
Notes for installation	14

Operation procedure

Part identification	15
Air direction adjustment	15
Remote control operation procedure	16
Remote control panel	20
Operation Tips	22

Care and maintenance

Caution	23
Care and maintenance	24
Troubleshooting guide	26
After service	27
Safety operation of flammable refrigerant	28

Please read this user's manual carefully before operating the unit.



Appliance filled with mildly flammable refrigerant R32.



Before use the appliance, read the user's manual.



User's manual.



Before repair the appliance, read the service manual.

The figures in this manual may be different with the material objects, please refer to the material objects for reference.

Explanation of Symbols



Indicates a hazardous situation that, if not avoided, will result in death or serious injury.



Indicates a hazardous situation that, if not avoided, could result in death or serious injury.



Indicates a hazardous situation that, if not avoided, may result in minor or moderate injury.

NOTICE

Indicates important but not hazard-related information, used to indicate risk of property damage.



Indicates a hazard that would be assigned a signal word WARNING or CAUTION.

Exception Clauses

Manufacturer will bear no responsibilities when personal injury or property loss is caused by the following reasons.

1. Damage the product due to improper use or misuse of the product;
2. Alter, change, maintain or use the product with other equipment without abiding by the instruction manual of manufacturer;
3. After verification, the defect of product is directly caused by corrosive gas;
4. After verification, the defects are due to improper operation during transportation of product;
5. Operate, repair, maintain the unit without abiding by instruction manual or related regulations;
6. After verification, the problem or dispute is caused by the quality specification or performance of parts and components that produced by other manufacturers;
7. The damage is caused by natural calamities, bad using environment or force majeure.

If it needs to install, remove or maintain the air conditioner, please contact dealer or local service center to conduct it at first. Air conditioner must be installed, removed or maintained by appointed unit. Otherwise, it may cause serious damage or personal injury or death.

When refrigerant leaks or requires discharge during installation, maintenance, or recycling, it should be handled by certified professionals or otherwise in compliance with local laws and regulations.

● The Refrigerant

- To realize the function of the air conditioner unit, a special refrigerant circulates in the system. The used refrigerant is R32. The refrigerant is mildly flammable and inodorous. Furthermore, it can lead to explosion under certain conditions. But the flammability of the refrigerant is very low. It can be ignited only by fire.
- Compared to common refrigerants, R32 is a nonpolluting refrigerant with no harm to the ozoneosphere. The influence upon the greenhouse effect is also lower. R32 has got very good thermodynamic features which lead to a really high energy efficiency. The units therefore need a less filling.

WARNING:

Do not use means to accelerate the defrosting process or to clean, other than those recommended by the manufacture. Should repair be necessary, contact your nearest authorized Service Centre.

The installation work shall be carried out by qualified personnel.

Any repairs carried out by unqualified personnel may be dangerous.

The appliance shall be stored in a room without continuously operating ignition sources. (for example: open flames , an operating gas appliance or an operating electric heater.)

Do not pierce or burn.

The appliance is using mildly flammable refrigerant R32 and tested to comply with IEC 60335-2-40. There is no minimum room area requirement for the appliance. Appliance filled with mildly flammable refrigerant R32. For repairs, strictly follow manufacturer's instructions only.

The lower limit of the installation height of this product is 0.75 meters.

Be aware that refrigerants may not contain an odour.

Read specialist's manual.



According to EN60335-1

This appliance can be used by children aged from 8 years and above and persons with reduced physical, sensory or mental capabilities or lack of experience and knowledge if they have been given supervision or instruction concerning use of the appliance in a safe way and understand the hazards involved.

Children shall not play with the appliance.

Cleaning and user maintenance shall not be made by children without supervision.

● Specialist's Manual

- **The following checks shall be applied to installations using flammable refrigerants:**
 - the charge size is in accordance with the room size within which the refrigerant containing parts are installed;
 - the ventilation machinery and outlets are operating adequately and are not obstructed;
 - if an indirect refrigerating circuit is being used, the secondary circuit shall be checked for the presence of refrigerant;
 - marking to the equipment continues to be visible and legible. Markings and signs that are illegible shall be corrected;
 - refrigeration pipe or components are installed in a position where they are unlikely to be exposed to any substance which may corrode refrigerant containing components, unless the components are constructed of materials which are inherently resistant to being corroded or are suitably protected against being so corroded.
- **Repair and maintenance to electrical components shall include initial safety checks and component inspection procedures. If a fault exists that could compromise safety, then no electrical supply shall be connected to the circuit until it is satisfactorily dealt with. If the fault cannot be corrected immediately but it is necessary to continue operation, an adequate temporary solution shall be used. This shall be reported to the owner of the equipment so all parties are advised.**
- **Initial safety checks shall include:**
 - that capacitors are discharged: this shall be done in a safe manner to avoid possibility of sparking;
 - that no live electrical components and wiring are exposed while charging, recovering or purging the system;
 - that there is continuity of earth bonding.
- **Checks to the area**

Prior to beginning work on systems containing flammable refrigerants, safety checks are necessary to ensure that the risk of ignition is minimised.
- **Work procedure**

Work shall be undertaken under a controlled procedure so as to minimise the risk of a flammable gas or vapour being present while the work is being performed.
- **General work area**

All maintenance staff and others working in the local area shall be instructed on the nature of work being carried out. Work in confined spaces shall be avoided.

● Specialist's Manual

- **Checking for presence of refrigerant**

The area shall be checked with an appropriate refrigerant detector prior to and during work, to ensure the technician is aware of potentially toxic or flammable atmospheres. Ensure that the leak detection equipment being used is suitable for use with all applicable refrigerants, i.e. non-sparking, adequately sealed or intrinsically safe.

- **Presence of fire extinguisher**

If any hot work is to be conducted on the refrigerating equipment or any associated parts, appropriate fire extinguishing equipment shall be available to hand. Have a dry powder or CO₂ fire extinguisher adjacent to the charging area.

- **No ignition sources**

No person carrying out work in relation to a refrigerating system which involves exposing any pipe work shall use any sources of ignition in such a manner that it may lead to the risk of fire or explosion. All possible ignition sources, including cigarette smoking, should be kept sufficiently far away from the site of installation, repairing, removing and disposal, during which refrigerant can possibly be released to the surrounding space. Prior to work taking place, the area around the equipment is to be surveyed to make sure that there are no flammable hazards or ignition risks. "No Smoking" signs shall be displayed.

- **Ventilated area**

Ensure that the area is in the open or that it is adequately ventilated before breaking into the system or conducting any hot work. A degree of ventilation shall continue during the period that the work is carried out. The ventilation should safely disperse any released refrigerant and preferably expel it externally into the atmosphere.

- **Checks to the refrigeration equipment**

Where electrical components are being changed, they shall be fit for the purpose and to the correct specification. At all times the manufacturer's maintenance and service guidelines shall be followed. If in doubt, consult the manufacturer's technical department for assistance.

- **Checks to electrical devices**

- that capacitors are discharged: this shall be done in a safe manner to avoid possibility of sparking;
- that no live electrical components and wiring are exposed while charging, recovering or purging the system.

- **Repairs to sealed components**

During repairs to sealed components, all electrical supplies shall be disconnected from the equipment being worked upon prior to any removal of sealed covers, etc. If it is absolutely necessary to have an electrical supply to equipment during servicing, then a permanently operating form of leak detection shall be located at the most critical point to warn of a potentially hazardous situation.

Particular attention shall be paid to the following to ensure that by working on electrical components, the casing is not altered in such a way that the level of protection is affected. This shall include damage to cables, excessive number of connections, terminals not made to original specification, damage to seals, incor-

Specialist's Manual

rect fitting of glands, etc.

- Ensure that the apparatus is mounted securely.
- Ensure that seals or sealing materials have not degraded to the point that they no longer serve the purpose of preventing the ingress of flammable atmospheres. Replacement parts shall be in accordance with the manufacturer's specifications.

NOTE: The use of silicon sealant can inhibit the effectiveness of some types of leak detection equipment. Intrinsically safe components do not have to be isolated prior to working on them.

- **Repair to intrinsically safe components**

Do not apply any permanent inductive or capacitance loads to the circuit without ensuring that this will not exceed the permissible voltage and current permitted for the equipment in use.

Intrinsically safe components are the only types that can be worked on while live in the presence of a flammable atmosphere. The test apparatus shall be at the correct rating.

Replace components only with parts specified by the manufacturer. Other parts may result in the ignition of refrigerant in the atmosphere from a leak.

- **Cabling**

Check that cabling will not be subject to wear, corrosion, excessive pressure, vibration, sharp edges or any other adverse environmental effects. The check shall also take into account the effects of aging or continual vibration from sources such as compressors or fans.

- **Leak detection methods**

Leak detection fluids are suitable for use with most refrigerants but the use of detergents containing chlorine shall be avoided as the chlorine may react with the refrigerant and corrode the copper pipe-work.

- **Detection of flammable refrigerants**

Under no circumstances shall potential sources of ignition be used in the searching for or detection of refrigerant leaks. A halide torch (or any other detector using a naked flame) shall not be used.

The following leak detection methods are deemed acceptable for all refrigerant systems.

Electronic leak detectors may be used to detect refrigerant leaks but, in the case of flammable refrigerants, the sensitivity may not be adequate, or may need re-calibration. (Detection equipment shall be calibrated in a refrigerant-free area.) Ensure that the detector is not a potential source of ignition and is suitable for the refrigerant used. Leak detection equipment shall be set at a percentage of the **LFL** of the refrigerant and shall be calibrated to the refrigerant employed, and the appropriate percentage of gas (25% maximum) is confirmed.

Leak detection fluids are also suitable for use with most refrigerants but the use of detergents containing chlorine shall be avoided as the chlorine may react with the refrigerant and corrode the copper pipe-work.

NOTE: Examples of leak detection fluids are

- bubble method,
- fluorescent method agents.

Specialist's Manual

If a leak is suspected, all naked flames shall be removed/extinguished.

If a leakage of refrigerant is found which requires brazing, all of the refrigerant shall be recovered from the system, or isolated (by means of shut off valves) in a part of the system remote from the leak.

● **Removal and evacuation**

When breaking into the refrigerant circuit to make repairs - or for any other purpose - conventional procedures shall be used. However, for flammable refrigerants it is important that best practice is followed since flammability is a consideration. The following procedure shall be adhered to:

- remove refrigerant;
- purge the circuit with inert gas;
- evacuate ;
- purge with inert gas ;
- open the circuit by cutting or brazing..

The refrigerant charge shall be recovered into the correct recovery cylinders. For appliances containing flammable refrigerants, the system shall be purged with oxygen-free nitrogen to render the appliance safe for flammable refrigerants. This process may need to be repeated several times. Compressed air or oxygen shall not be used for purging refrigerant systems.

For appliances containing flammable refrigerants, refrigerants purging shall be achieved by breaking the vacuum in the system with oxygen-free nitrogen and continuing to fill until the working pressure is achieved, then venting to atmosphere, and finally pulling down to a vacuum. This process shall be repeated until no refrigerant is within the system. When the final oxygen-free nitrogen charge is used, the system shall be vented down to atmospheric pressure to enable work to take place. This operation is absolutely vital if brazing operations on the pipe-work are to take place.

Ensure that the outlet for the vacuum pump is not close to any potential ignition sources and that ventilation is available.

● **Charging procedures**

In addition to conventional charging procedures, the following requirements shall be followed.

- Ensure that contamination of different refrigerants does not occur when using charging equipment. Hoses or lines shall be as short as possible to minimise the amount of refrigerant contained in them.
- Cylinders shall be kept in an appropriate position according to the instructions.
- Ensure that the refrigerating system is earthed prior to charging the system with refrigerant.
- Label the system when charging is complete (if not already).
- Extreme care shall be taken not to overfill the refrigerating system.

Prior to recharging the system, it shall be pressure-tested with the appropriate purging gas. The system shall be leak-tested on completion of charging but prior to commissioning. A follow up leak test shall be carried out prior to leaving the site.

● **Decommissioning**

Before carrying out this procedure, it is essential that the technician is completely

● Specialist's Manual

familiar with the equipment and all its detail. It is recommended good practice that all refrigerants are recovered safely. Prior to the task being carried out, an oil and refrigerant sample shall be taken in case analysis is required prior to reuse of reclaimed refrigerant. It is essential that electrical power is available before the task is commenced.

a) Become familiar with the equipment and its operation.

b) Isolate system electrically.

c) Before attempting the procedure, ensure that:

– mechanical handling equipment is available, if required, for handling refrigerant cylinders;

– all personal protective equipment is available and being used correctly;

– the recovery process is supervised at all times by a competent person;

– recovery equipment and cylinders conform to the appropriate standards.

d) Pump down refrigerant system, if possible.

e) If a vacuum is not possible, make a manifold so that refrigerant can be removed from various parts of the system.

f) Make sure that cylinder is situated on the scales before recovery takes place.

g) Start the recovery machine and operate in accordance with manufacturer's instructions.

h) Do not overfill cylinders. (No more than 80% volume liquid charge).

i) Do not exceed the maximum working pressure of the cylinder, even temporarily.

j) When the cylinders have been filled correctly and the process completed, make sure that the cylinders and the equipment are removed from site promptly and all isolation valves on the equipment are closed off.

k) Recovered refrigerant shall not be charged into another refrigeration system unless it has been cleaned and checked.

● Labelling

Equipment shall be labelled stating that it has been de-commissioned and emptied of refrigerant. The label shall be dated and signed. For appliances containing flammable refrigerants, ensure that there are labels on the equipment stating the equipment contains flammable refrigerant.

● Recovery

When removing refrigerant from a system, either for servicing or decommissioning, it is recommended good practice that all refrigerants are removed safely.

When transferring refrigerant into cylinders, ensure that only appropriate refrigerant recovery cylinders are employed. Ensure that the correct number of cylinders for holding the total system charge are available. All cylinders to be used are designated for the recovered refrigerant and labelled for that refrigerant (i.e. special cylinders for the recovery of refrigerant). Cylinders shall be complete with pressure-relief valve and associated shut-off valves in good working order. Empty recovery cylinders are evacuated and, if possible, cooled before recovery occurs.

The recovery equipment shall be in good working order with a set of instructions concerning the equipment that is at hand and shall be suitable for the recovery of all appropriate refrigerants including, when applicable, flammable refrigerants. In addition, a set of calibrated weighing scales shall be available and in good working

● Specialist's Manual

order. Hoses shall be complete with leak-free disconnect couplings and in good condition. Before using the recovery machine, check that it is in satisfactory working order, has been properly maintained and that any associated electrical components are sealed to prevent ignition in the event of a refrigerant release. Consult manufacturer if in doubt.

The recovered refrigerant shall be returned to the refrigerant supplier in the correct recovery cylinder, and the relevant waste transfer note arranged. Do not mix refrigerants in recovery units and especially not in cylinders.

If compressors or compressor oils are to be removed, ensure that they have been evacuated to an acceptable level to make certain that flammable refrigerant does not remain within the lubricant. The evacuation process shall be carried out prior to returning the compressor to the suppliers. Only electric heating to the compressor body shall be employed to accelerate this process. When oil is drained from a system, it shall be carried out safely.

Precautions

WARNING

Children shall not play with the appliance.

Cleaning and user maintenance shall not be made by children without supervision.

The air conditioner should be installed in accordance with national wiring regulations. Air Conditioner should be properly grounded. Incorrect grounding may cause electric shock.

- This appliance can be used by children aged from 8 years and above and persons with reduced physical, sensory or mental capabilities or lack of experience and knowledge if they have been given supervision or instruction concerning use of the appliance in a safe way and understand the hazards involved.
- Do not connect air conditioner to multi-purpose socket. Otherwise, it may cause fire hazard.
- Do not install the air switch. If not, it may cause malfunction.
- Do not spill water on the remote controller, otherwise the remote controller may be broken.
- Do not spray water on air conditioner. It may cause electric shock or malfunction.
- Do not extend fingers or objects into air inlet or air outlet. It may cause personal injury or damage.
- Do not step on air conditioner, or put heavy objects. It may cause damage or personal injury.
- Do not block air outlet or air inlet. It may cause malfunction.
- Do not disconnect power supply when cleaning air conditioner. Otherwise, it may cause electric shock.
- Do not repair air conditioner by yourself. It may cause electric shock or damage. Please contact dealer when you need to repair air conditioner.
- Maintenance must be performed by qualified professionals. Otherwise, it may cause injury or damage.
- The appliance is not to be used by persons (including children) with reduced physical, sensory or mental capabilities, or lack of experience and knowledge, unless they have been given supervision or instruction.
- Children being supervised not to play with the appliance.

Please install the devices for short-circuit protection and electrical leakage protection when installing the air conditioner.

According to the local safety regulations, use qualified power supply circuit and circuit break.

Working temperature range

※ Operating Temperature Range		
	Indoor side DB/WB(°C)	Outdoor side DB/WB(°C)
Maximum cooling	32/23	43/-

The operating temperature range (outdoor temperature) for cooling only unit is 18°C~ 43°C.

● Function

Introduction

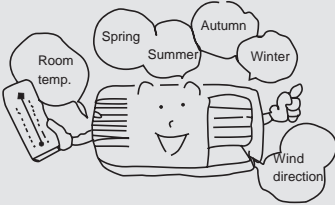

Window type room air conditioners can regulate the room temperature and dry the room. It is convenient for your work, study and life. It can be widely used in residence, shop, hotel, office, library and laboratory, and so on.

Cooling in summer

In hot summer, Air conditioner can cool down the room air by transferring heat out.

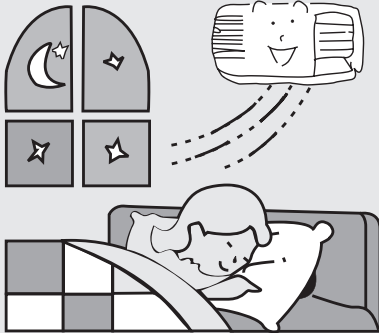

Dehumidifying in rainy or humid season

Without reducing the room temp., air conditioner can dehumidify and make the room air dry and comfortable.

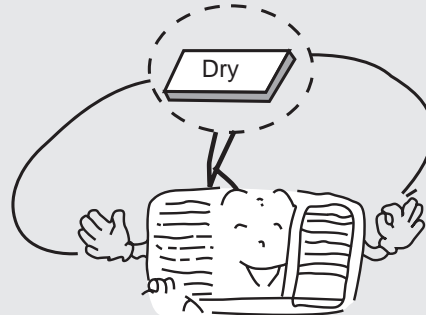



● Operating Condition

- Please operate air conditioner in the correct conditions as following.

COOL mode operation	DRY mode operation
<p>Outdoor temperature should be in range of 18°C to 43°C , otherwise it is possible for air conditioner to breakdown.</p> <p>Room humidity should be lower than 90%. Otherwise, it is possible for air conditioner to dew at air conditioner surface and even drop water after running for so much time. But this is normal.</p>	<p>Outdoor temperature should be in range of 18°C to 43°C , otherwise it is possible for air conditioner to breakdown.</p>

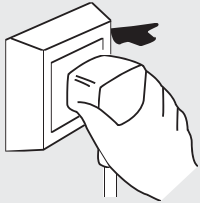
Power requirement

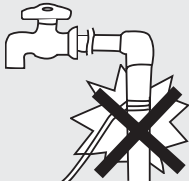
	<p>* The electric components will be damaged when the voltage is too high. If the voltage is too low, the compressor will vibrate violently to damage the refrigerant system and easily cause the compressor and electric components not work.</p>	
	<p>The ground must be connected.</p> <p>* Special socket must be used. Furthermore, the socket and wiring must conform to the wiring regulations. And the earthing method must be reliable.</p> <p>* In fixed circuit, there must be electricity leakage protection switch of enough power capacity and air switch with enough space.</p>	
<p>Earth wire To ensure the reliable earthing, please do not connect earth wire to the following places:</p>		
<p>Water pipe </p>		

● Installation

Installation precaution:

Window type air conditioner is so valuable and the improper installation of it will cause a lot of damage! Please associate the professional technician to install the unit and don't install it by yourself. Otherwise, we are not responsible for the damage like this.



Location:

- The minimum installation height of R32 window type unit must be over 750mm.
- The condensation water must be drained away conveniently.
- Install air conditioner unit far away from TV set or radio etc. to avoid disturbing video or voice.
- In salt and coastal area or place where is near thermal springs and polluted by sulphurous gas, or other special areas, please contact the seller before use.
- Avoid a place where is possible for inflammable gas to leak out.
- It's not allowed to be installed on the unstable or motive base structure (such as truck) or in the corrosive environment (such as chemical factory).
- Avoid other heat sources or direct sun light.
- Avoid a place where is easy for children to touch.
- Don't use the unit in the immediate surroundings of a laundry, a bath, a shower or a swimming pool.
- For window type air conditioner with remote control, install in a location where is strong electromagnetic disturbance, you should contact the seller in advance to avoid the malfunction in use.

How to install:

- Installation must be performed by authorized dealers and professionally trained technicians.
- Choose a location where there are no any obstacle surrounding the unit, and the plug is accessible.
- Prepare the installation hole slightly bigger than unit size.
- Choose the installation space according to the following diagram.

The distance between the air conditioner 300mm and the around obstacles should meet the requirement as below: over 300mm(upper side), over 500mm (left side), over 500mm (right side), over 1500mm (front side) and over 500mm (rear side).

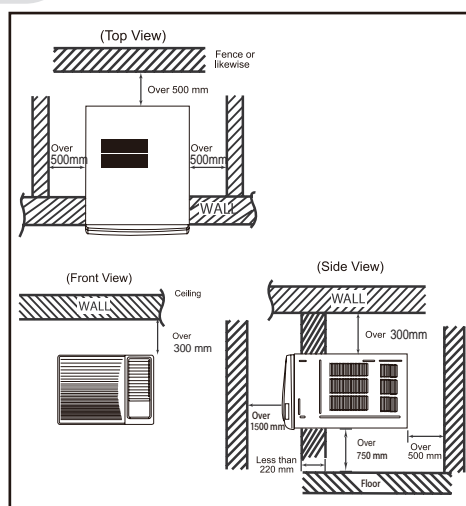

Installation procedure:

- 1) Remove the sticker from the front panel.
- 2) Put the unit into the installation hole.
 - When installing the unit, it should be slanted down to the back to avoid the enlargement of noise or vibration. (Slant between 6-10mm.) (Shown at right figure.)
 - The installation place should be strong enough to avoid the enlargement of noise or vibration.
- 3) Fill up sews in the cabinet with sponge or foam.

Installation assistance:

- Use iron support
The installation hole should be strong enough to support the air conditioner. If it cannot, iron support has to be used outdoors.
Iron support should be fixed on the building (Shown at right figure.)
- Use sunshade board
Air conditioner should avoid anything to be dropped into it and avoid direct sunshine. If there is no cover on it, you should contact the seller for installing the sunshade board. When installing the sunshade board, don't let it block the air inlet at the side grille.

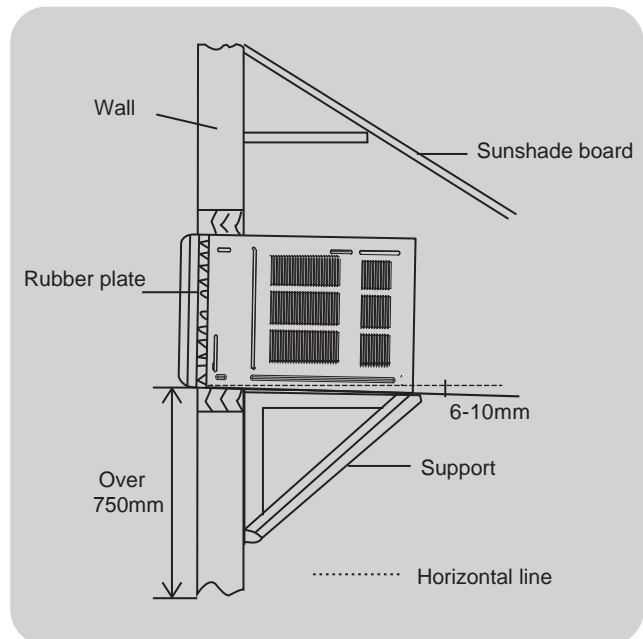

Drain water for one style:

To get the maximum cooling efficiency, the air conditioner is designed to splash the condensate on the condenser coil.

If the splashing sound annoys you, you can provide an outside drain by using the following procedure, which may however cause a small loss of performance.

1. There is a drainage outlet at the back of the unit.
2. Remove cover from the drainage outlet, and then connect drainage joint to it with screw.
3. Connect the drain hose to the outlet.

Note:

Drain hose or tubing can be purchased locally to satisfy your particular needs.

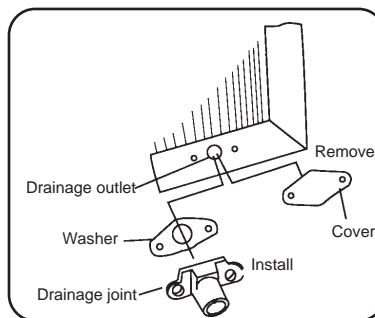

Drain water for another style:

To get the maximum cooling efficiency, the air conditioner is designed to splash the condensation water on the condenser coil.

To the cooling only unit, If the splashing sound annoys you, you can provide an outside drain by using the following procedure, which may however cause a small loss of performance.

1. Slide out the chassis from the cabinet.
2. Remove the rubber plug from the body base plate.
3. Install the drain pan to the corner of the cabinet with 2 screws.
4. Connect the drain hose to the outlet on the drain pan bottom.
5. Slide the chassis into its original place in the cabinet.

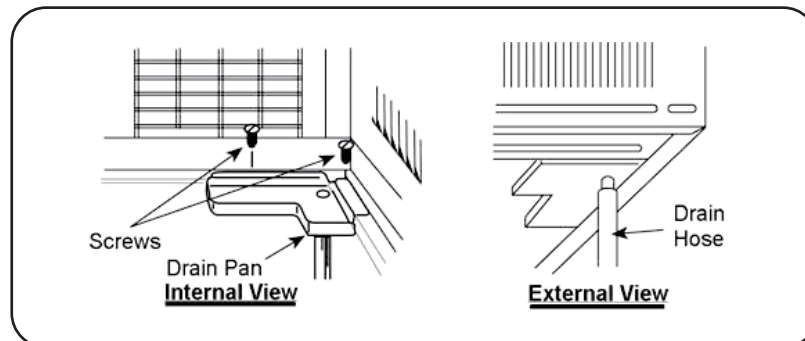

● Notes for installation

Remove

Before removing air conditioner to the other place, you should contact the seller firstly.
Then it must be done under the direction of the professional technician. In addition, the charge of this must be paid.

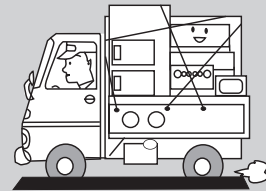

Noise

- Install in a location where is firm enough to avoid the enlargement of noise and vibration.
- Don't put anything in front of the outlet of the unit to avoid increasing noise.
- Be sure that hot air or noise will not inconvenience neighbors.
- Please contact the seller as soon as there is strange noise during operation.
- Please use the safety support.

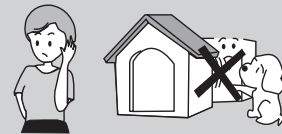

Electric wiring

- Must connect with ground reliably.
- The exclusive circuit must be used. But removable socket can't be used because poor contact of it can cause over heat or fire.
- Don't pull the power cord strongly.
- In fixed circuit, there must be electricity leakage protection switch and leakage current is less than 30mA.
- Air switch (thermal-magnetic breaker) should be installed in the circuit and its capacity is 10A (07K、09K、12K) / 16A (18K、24K).
- Connecting method between air conditioners and power cord and interconnecting method of each individual element with one another should accord with wiring diagram on the unit.
- The air conditioner should be installed in accordance with national wiring regulations.
- An all-pole disconnection switch having a contact separation of at least 3mm in all poles should be connected in fixed wiring.
- If the supply cord is damaged, it must be replaced by the manufacturer or your dealer or a qualified person to avoid a hazard.
- All the electrical work must be done according to the local wiring regulations.

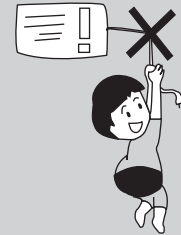

● Part identification

Panel outlook picture, just for reference, please take the real unit as standard.

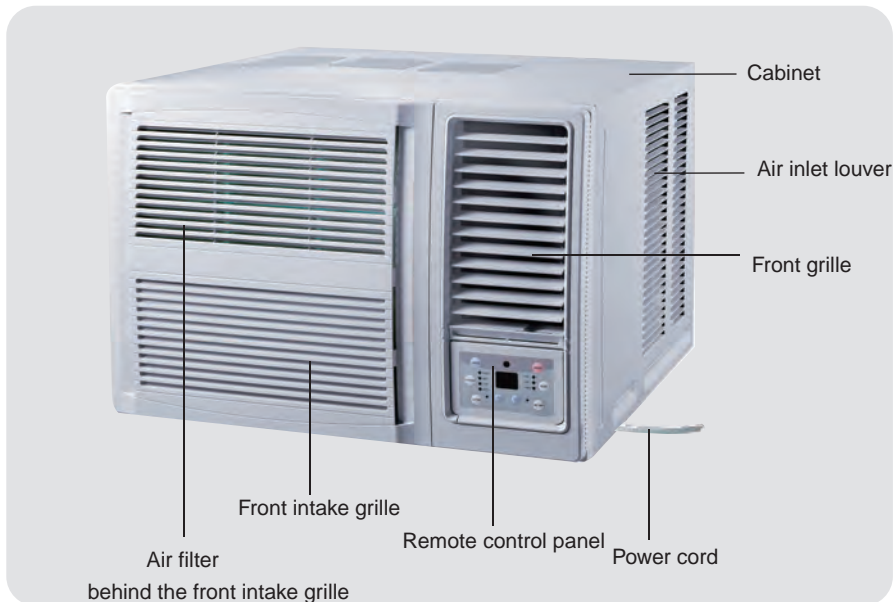

Air direction adjustment

Vertical airflow direction vane

(Airflow direction adjustment up and down)

The vertical airflow direction vane is controlled by positioning the vane to discharge the air upwards, downwards or straight out.

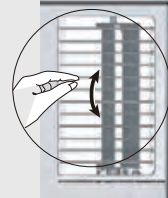

Installation method for 3-in-1 air filter

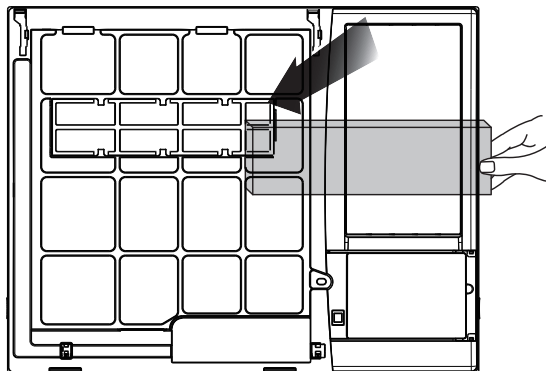

● FYa chY`Wcblfc``cdYfUjcb`dfcWXi fY

Note:

This is a general use remote controller, it could be used for the air conditioners with multifunction; For some function, which the model doesn't have, if press the corresponding button on the remote controller that the unit will keep the original running status.

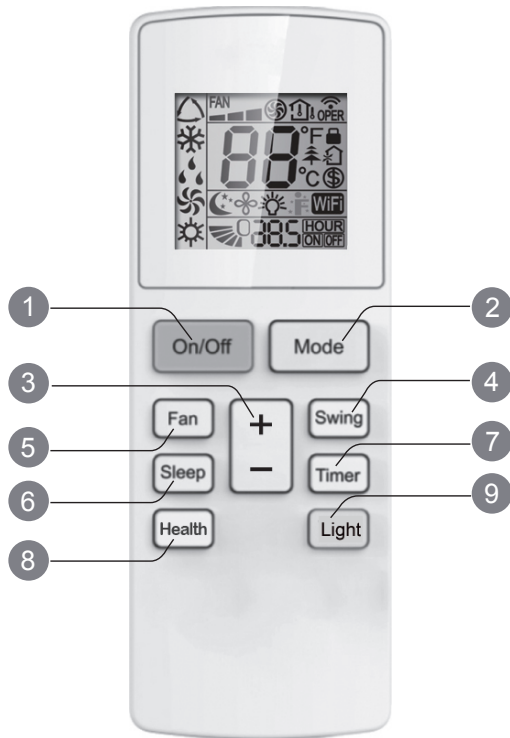

- ① On/Off button
- ② Mode button
- ③ + / - button
- ④ Swing button
- ⑤ Fan button
- ⑥ Sleep button
- ⑦ Timer button
- ⑧ Health button(not applicable)
- ⑨ Light button

① On/Off button

Press this button to turn on the unit.
Press this button again to turn off the unit.

② Mode button

Press this button can your required operation mode in turn. Corresponding indicator will be on.

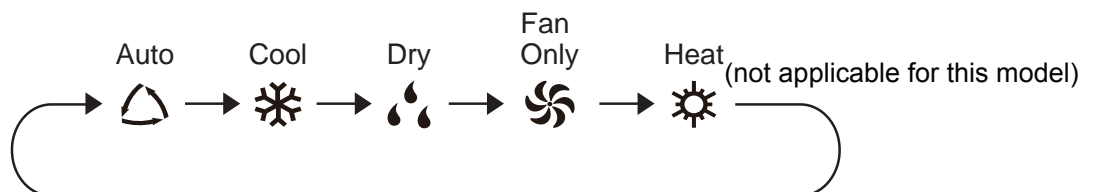

- **Auto:** Under this mode, the unit will operate automatically according to ex-factory setting. In this case, set temperature cannot be adjusted.
- **Cool:** Under this mode, air conditioner operates under cooling mode. Cooling indicator will be on. Press "Fan Speed" button can adjust the fan speed.

- **Dry:** Under this mode, the unit runs in low fan speed for dehumidification and the corresponding indicator is on; under dry mode, the fan speed cannot be adjusted.
- **Fan Only:** Under this mode, air conditioner will not cool or heat, only blow wind. Fan indicator will be on. Press “Fan Speed” button can adjust the fan speed.
- **Heat:** Under this mode, air conditioner operates under heating mode. Press “Fan Speed” button can adjust the fan speed.(Cooling only unit won't receive heating mode signal. If setting heat mode with remote controller, press ON/OFF button can't start up the unit).



3 + / - button

- Pressing “+” or “-” button once will increase or decrease set temperature by 1°F(°C).
Hold “+” or “-” button for 2s, set temperature on remote controller will change quickly.
Release the button after your required set temperature is reached.
- Under timer setting status, after each pressing of “+” or “-” button, time will increase or decrease 0.5h . Hold “+” or “-” button, 2s later, time displayed on dual-8 nixie tube will change quickly. Loosen the button until the time is reached to your set time.

4 Swing button

Press this button to turn “ON” & “OFF” swing function.

5 Fan button

This button is used for setting Fan Speed in the sequence that goes from AUTO, , , to  then back to Auto.

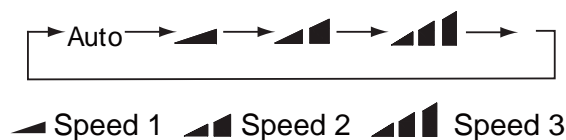

NOTE: There are 3 speeds for the Fan Speed of this model.

6 Sleep button

Press this button to go into the Sleep operation mode. Press it again to cancel this function. This function is available in COOL, HEAT (Only for models with heating function) mode to maintain the most comfortable temperature for you.

7 Timer button

Under ON status, press this button to set timer OFF; Under OFF status, press this button to set timer ON.

Press this button once and the characters of HOUR ON (OFF) will flash to be displayed. Meanwhile, press "+" button or "-" button to adjust timer setting (time will change quickly if holding "+" or "-" button). Time setting range is 0.5~24hours. Press this button again to confirm timer setting and the characters of HOUR ON (OFF) will stop flashing.

If the characters are flashing but you haven't press timer button, timer setting status will be quit after 5s. If timer is confirmed, press this button again to cancel timer.

8 Health button

- This function is not applicable for this model.

9 Light button

Press "Light" button to turn on or off the lights on the display panel of the window air conditioner.

Function introduction for combination buttons

Temperature display switchover function

Under OFF status, press "-" and "Mode" buttons simultaneously to switch temperature display between °C and °F.

Replacement of batteries in remote controller

1. Press the back side of remote controller marked with "  ", as shown in the fig, and then push out the cover of battery box along the arrow direction.
2. Replace two 7# (AAA 1.5V) dry batteries, and make sure the position of "+" polar and "-" polar are correct.
3. Reinstall the cover of battery box.

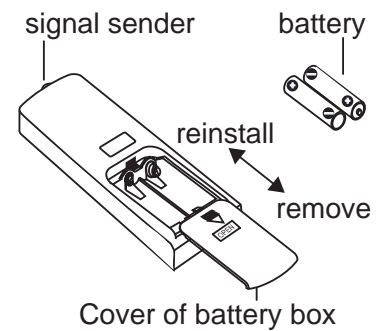

NOTICE

- The distance between signal sender and receiving window should be no more than 8m, and there should be no obstacles between them.
- As the signal will be interfered in the room with electronic fluorescent lamp, conversion fluorescent lamp or wireless phone, please get closer to the air conditioner when using the remote controller.
- Replace new batteries of the same model when replacement is required.
- When you don't use remote controller for a long time, please take out the batteries.

Remote control panel

Note:

- If wireless remote controller is lost, you can use the remote control panel and operate manually.
- The schematic diagram of membrane in the instruction manual is only for reference. Please refer to the actual product.

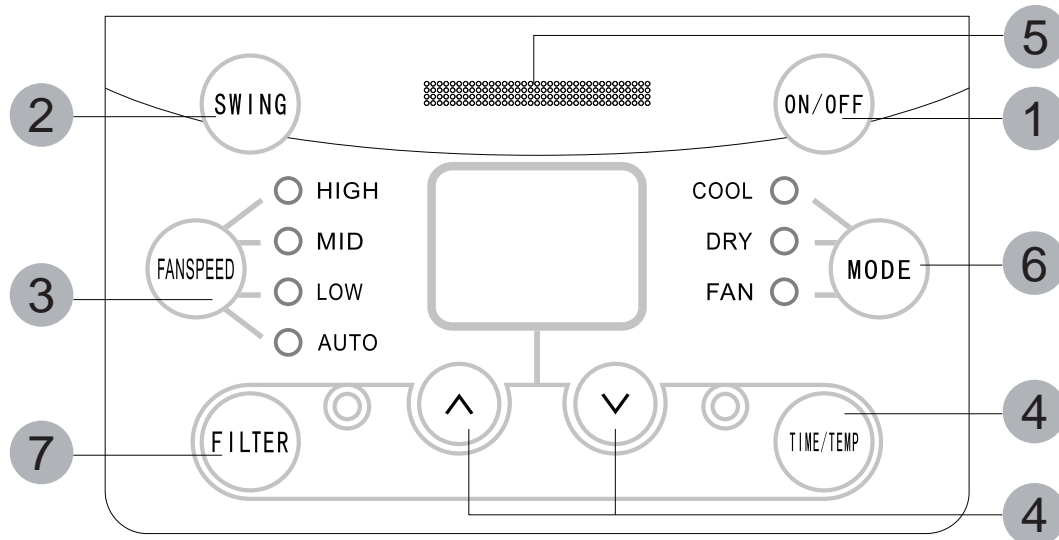

1 ON/OFF BUTTON

Operation starts when pressing this button, and stops when pressing this button again.

2 SWING BUTTON

Activate the automatic air swing function.

3 FAN SPEED BUTTON

Select the fan speed LOW, MID, HIGH and AUTO in sequence.

4 TIME/TEMP BUTTON

Press the \wedge keypad to increase the set (operating) temperature of the unit. and Press the \vee keypad to decrease the set (operating) temperature of the unit. The temperature setting range is from 16~30°C. Press the \wedge keypad also to increase the selected time in 0.5 hour increments, and Press the \vee keypad to to decrease the selected time in 0.5 hour decrements, the time setting range is from 0~10 hours. Press the \wedge keypad also to the selected time in 1 hour increments, and Press the \vee keypad to decrease the selected time in 1 hour decrements. The time setting range is from 0-24 hours.

5 SIGNAL RECEIVER

6 MODE BUTTON

COOL, DRY, FAN (for cooling only model).

7 FILTER BUTTON

This feature is a reminder to clean the Air Filter (See Care and Cleaning) for more efficient operation and cooling. The LED (light) will illuminate after 250 hours of operation. To reset after cleaning the filter, press the "Check Filter" button and the light will go off. Before the LED(light) illuminate, press the "Check filter" button until after 3 seconds, the accumulated time of operation will be canceled.

● Operation Tips

Operation for comfort and economy

Do not overcool the room temperature. This is not good for health and wastes electricity.

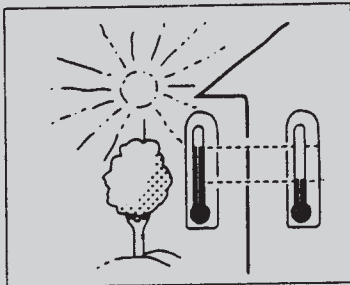

Keep blind or curtains closed
Do not let sunshine enter the room directly when the air conditioner is in operation.

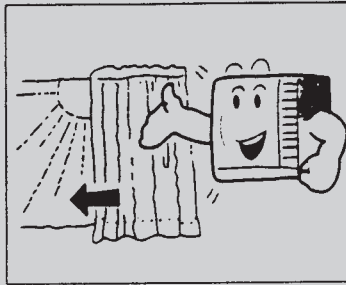

Keep the room temp. stable
Adjust the vertical and horizontal airflow direction to ensure a stable temperature in the room. Air can't be discharged to the direction of air-in.

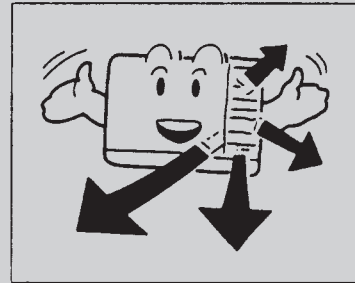

Make sure that the doors and windows are tightly closed. Avoid opening doors and windows as much as possible to keep air conditioning in the room.

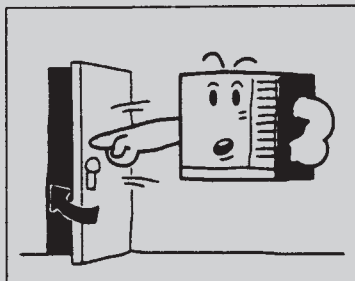

Clean the air filter regularly.
Blockages in the air filter reduce dehumidifying effects.
Clean the air filter at least once every two weeks.

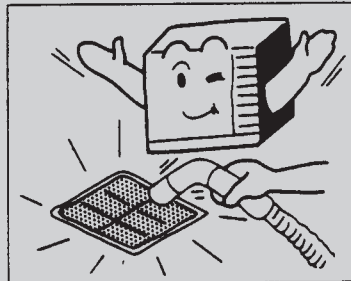

Ventilate the room occasionally
Since windows are kept closed, it is a good idea to open them and ventilate the room now and then. When starting the unit, curtains or windows should be closed to prevent the heat/cool leakage.

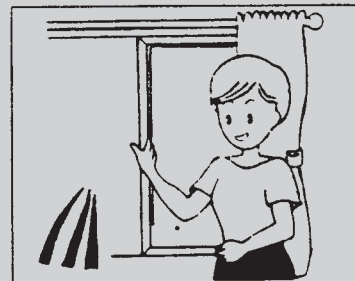

● CAUTION

Operations for safety and health

- 1) The plug must be accessible after the appliance is positioned.
- 2) Do not use this appliance in the laundry.
- 3) If the power cord is damaged, it must be replaced by the manufacture or its service agent in avoid of hazard.

- Do not pull out the power cord.
- Damage to the cord may result in serious electric shocks.

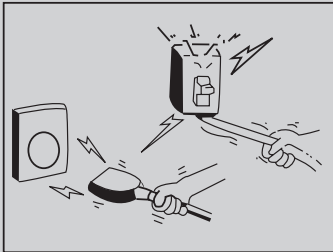

- Do not use the air conditioner for other purposes except for cooling the room.
- Do not use the air conditioner for other purposes such as drying clothes, preserving foods, or cultivating vegetables.

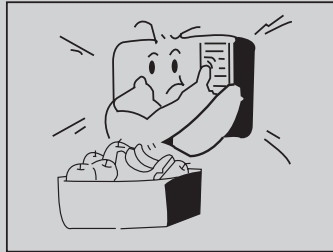

- Do not block the air intake and outlet vents
This causes lowered performance and irregular operation.
- Do not insert sticks or other objects into these vents as it is dangerous to touch the electric components and the fan.



Select the most appropriate temperature.
Pay attention to adjust the temperature to suit the conditions.
Rooms occupied by infants, the elderly, or the sick should be kept at an appropriate temperature.

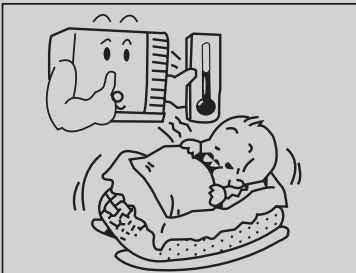

Do not use heating apparatuses in the vicinity. The air conditioner's plastic parts will melt if exposed to excessive heat.

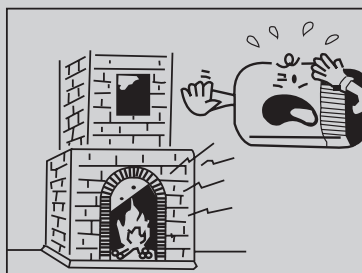

Avoid exposing the body directly to a continuous unidirectional air flow for long periods.
This is not recommended for health reason.

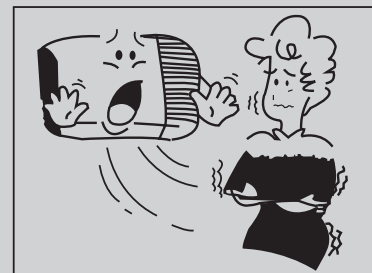

Always wait at least 3 minutes before switching the air conditioner on again after you have switched it off during cooling or heating.

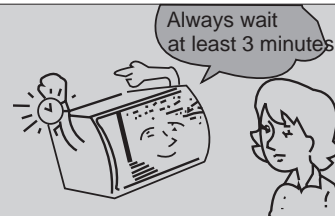

Please notice that the unit is filled with mildly flammable refrigerant R32. Inappropriate treatment of the unit involves the risk of severe damages of people and material. Details to this refrigerant are found in chapter "refrigerant".

The appliance is using mildly flammable refrigerant R32 and tested to comply with IEC 60335-2-40. There is no minimum room area requirement for the appliance.

● Care and maintenance

Always turn off the air conditioner and main power supply before cleaning to ensure safety.

Cleaning unit

1. Cut power off before cleaning.

Plug out only after air conditioner stops at all.

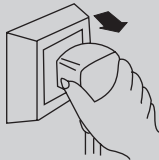

2. Use soft cloth when cleaning cabinet.

If the cabinet is very dirty, dip cloth into warm water below 40°C, dry the cloth and then rub off the dirt.



Dry the cloth by hands before cleaning.

3. Don't use gas, benzene, solvent, wash, chemical solvent, etc. for cleaning.



4. Do not splash water directly into the unit, in which there are micro-computer and circuit plate, they must not be drenched with water.



Accident could happen.

* Check earth wire

Is it broken or loose?

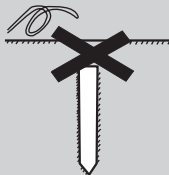

Air filter

The air filter behind the intake grille should be washed at least once every two weeks or as often as it needs cleaning.

How to clean the air filter:

1. To remove the air intake grille, grasp the tab on the filter and pull to take out.

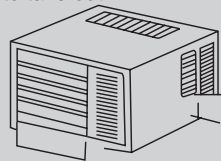

2. Vacuum the filter on the dusty side to remove light dust.

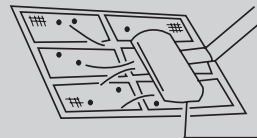

Vacuum cleaner

3. Wash the filter, cleaner side up under gently flowing water to wash out accumulated dust and lint.



4. If the filter is very dirty, use a mild household detergent in the wash water.



Let the filter dry thoroughly before reinstalling it. If, necessary, please ask the professional personnel to clean it.

* Check if air inlet and outlet of the unit are blocked or not.

Air lock could result in bad efficiency.



How to Remove and to Refit the Front Panel



WARNING

In the work of this item, the authorized service personnel should work.

Remove the front panel in the following manner

- 1 Remove the fixing screw.
There may also be screws on both edges of the front panel depending on the model type.

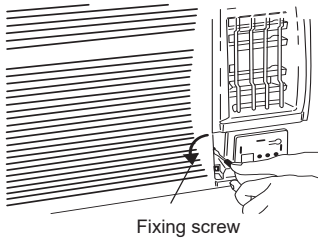

- 2 Hold up the front panel with your hands to remove it.

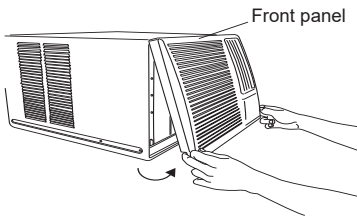

Refit the front panel in the following manner

- 1 Firstly the front panel is inset in two upper hooks and secondly it's inset in two lower hooks. The moving pole is inserted in a link plate surely.

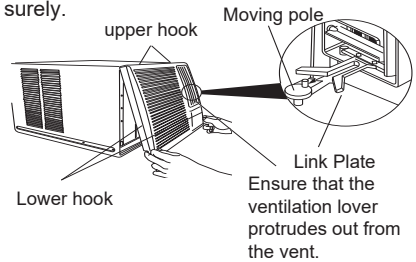

- 2 Adjust the position so that the light of the unit's display could be seen from the front panel's display. After adjusting, fasten the screws. There may also be screws on both edges of the front panel depending on the model type.

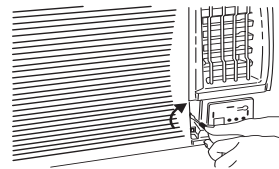

When Not Using the Unit for Extended Periods (One Month or More)

Operate the unit on fan mode for about one-half day on a day with clear weather, to assure that the internal parts are dry.

When not using the unit for extended periods, disconnect the power plug for safety.

Check the Power Cord



WARNING

If the power cord is damaged, it must be replaced by the manufacturer, its service agent, or similarly qualified persons in order to avoid a hazard.





Check the power cord occasionally to confirm that it is not damaged by cuts or abrasions.

Inspection and Repairs

Depending on the conditions of use, the internal parts of an air conditioner will become dirty after about two or three seasons of use, and performance may be affected. For this reason, regular professional maintenance is recommended. Consult authorized service personnel.

● Troubleshooting guide

Please check the following items before asking for repair, it saves your time and money.

Fault phenomenon	Trouble-shooting
<p>Air conditioner does not operate at all.</p> 	<ul style="list-style-type: none"> * Is there a power failure? * Is the plug out? * Is power fuse or switch off ? * Whether the voltage is too high or too low?
<p>Cool or heat efficiency is not good.</p> 	<ul style="list-style-type: none"> * Is air inlet or outlet locking? * Is there any other heat/cool source in room? * Are air filters dirty very much? * Is indoor fan speed set at LOW? * Maybe the room is too hot/cool when the unit is started.
<p>Foggy air flows out.</p> 	<ul style="list-style-type: none"> * At COOL mode operation, sometimes there is foggy air flowing out of the unit, this is because the room humid air has been cooling rapidly. * The unit is normal while the indoor outlet is sending out some odor, because the inlet air may be mixed with the smell of furniture and smoke.
<p>The air conditioner operation is noisy.</p> 	<ul style="list-style-type: none"> * For a noise that sounds like water flowing: This is the sound of freon flowing inside the air conditioner unit. * For a noise that sounds like a shower: This is the sound of the dehumidifying water being processed inside the air conditioner unit.
<p>It seems that condensation is leaking from air conditioner.</p>	<ul style="list-style-type: none"> * Condensation occurs when the airflow from the air conditioner cools the warm room air.
<p>Air conditioner does not operate for about 3 minutes when restart.</p>	<ul style="list-style-type: none"> * This is to protect the mechanism. * Wait about 3 minutes and operation will begin.

Malfunction code	Solution
H5	Please contact professional person to deal with it.
E5	Please contact professional person to deal with it.
E4	Please contact professional person to deal with it.
H3	Please contact professional person to deal with it.
H5	Please contact professional person to deal with it.
PL	Please contact professional person to deal with it.
PH	Please contact professional person to deal with it.
HC	Please contact professional person to deal with it.
Fo	Please contact professional person to deal with it.
F3	Please contact professional person to deal with it.
F4	Please contact professional person to deal with it.
F5	Please contact professional person to deal with it.
F0	Please contact professional person to deal with it.
E6	Please contact professional person to deal with it.
F1	Please contact professional person to deal with it.
F2	Please contact professional person to deal with it.
U7	Please contact professional person to deal with it.

Note: If there're other malfunction codes, please contact qualified professionals for service.

Immediately stop all operations and plug out, please contact your dealer in the following situations.

- *Operation starts or stops abnormally;
- *Power fuse or switch often breaks;
- *Carelessly splash water or something into air conditioner;
- *Electrical lines are much hot or lines cover breaks;
- *Other strange situations.



● Others

- The connection between AC and power cord or among other elements independently shall be subject to wiring diagram on the unit.
- Model and rated value of fuse shall be subject to screen print on corresponding controller or protective bushing.

● After service

- If your air conditioner has the questions of quality or anything else, please contact Shun Hing Electric Service Centre Ltd.

● Safety operation of flammable refrigerant

● Qualification requirement for installation and maintenance man

1. All the work men who are engaging in the refrigeration system should bear the valid certification awarded by the authoritative organization and the qualification for dealing with the refrigeration system recognized by this industry. If it needs other technician to maintain and repair the appliance, they should be supervised by the person who bears the qualification for using the flammable refrigerant.
2. It can only be repaired by the method suggested by the equipment's manufacturer.

● Installation notes

1. The air conditioner is not allowed to use in a room that has running fire (such as fire source, working coal gas ware, operating heater).
2. The appliance is using mildly flammable refrigerant R32 and tested to comply with IEC 60335-2-40.
There is no minimum room area requirement for the appliance.
3. Leak test is a must after installation.

● Maintenance notes

1. Check whether the maintenance area or the room area meet the requirement of the nameplate.
 - It's only allowed to be operated in the rooms that meet the requirement of the nameplate.
2. Check whether the maintenance area is well-ventilated.
 - The continuous ventilation status should be kept during the operation process.
3. Check whether there is fire source or potential fire source in the maintenance area.
4. Check whether the appliance mark is in good condition.
 - Replace the vague or damaged warning mark.

● **Welding**

1. If you should cut or weld the refrigerant system pipes in the process of maintaining, please follow the steps as below
 - a. Shut down the unit and cut power supply
 - b. eliminate the refrigerant
 - c. vacuuming
 - d. clean it with N₂ gas
 - e. cutting or welding
 - f. carry back to the service spot for welding
2. The refrigerant should be recycled into the specialized storage tank.
3. Make sure that there isn't any naked flame near the outlet of the vacuum pump and it's well-ventilated.

● **Filling the refrigerant**

1. Use the refrigerant filling appliances specialized for R32. Make sure that different kinds of refrigerant won't contaminate with each other.
2. The refrigerant tank should be kept upright at the time of filling refrigerant.
3. Stick the label on the system after filling is finished (or haven't finished)
4. Don't overfilling.
5. After filling is finished, please do the leakage detection before test running; another time of leak detection should be done when it's removed.

● **Safety instructions for transportation and storage**

1. Please use the flammable gas detector to check before unload and open the container.
2. No fire source and smoking.
3. According to the local rules and laws.

● Special Avowal

- 1. The information above has been checked; our company reserves the hermeneutic power to any print errors or misunderstanding on the content.**
- 2. Any technology improvement will add into new instruction without any prior notices. The product appearance and color refer to the practical air conditioner.**
- 3. The e-copy of user manual can be sent by e-mail on requested, please call Shun Hing Electric Works & Engineering Co. Ltd. hotline at 2861 2767.**

● After sale service

Guarantee period state from the date of purchasing to one year. If the product is damaged under proper use, a free repair service is available. Please present the official invoice and the guarantee certificate with the sales point's chop / redemption center's chop for free maintenance. For enquiries, please contact Shun Hing Electric Service Centre Limited hotline at 2406 5666.

Turn off the power and contact Shun Hing Electric Service Centre Ltd. as soon as any of the following events occur.

The circuit breaker frequently trips or the fuse blows regularly.

If water or foreign objects have accidentally entered the air conditioner.

If there is abnormal sound during operation.

信興電工工程有限公司

SHUN HING ELECTRIC WORKS & ENGINEERING CO., LTD

辦公室：香港九龍尖沙咀東部麼地道 67 號半島中心 9 樓

OFFICE: 9/F, PENINSULA CENTRE, 67 MODY ROAD, TSIMSHATSUI EAST,
KOWLOON, HONG KONG

電話 TEL: (852) 2861 2767

傳真 FAX: (852) 2865 6706

網址 WEBSITE: www.rasonic.com

電郵 EMAIL: shew@shunhinggroup.com

保養及維修 MAINTENANCE AND REPAIR SERVICE

信興電器服務中心有限公司

SHUN HING ELECTRIC SERVICE CENTRE LTD.

辦公室：香港新界葵涌勝耀街2號信興中心11樓

OFFICE: 11TH FLOOR, SHUN HING CENTRE, 2 SHING YIU STREET, KWAI CHUNG, NEW
TERRITORIES, HONG KONG

電話 TEL: (852) 2406 5666

傳真 FAX: (852) 2408 0316

網址 WEBSITE: www.shesc.com

消耗品/附件銷售熱線 CONSUMABLES/ ACCESSORIES SALES HOTLINE

電話 TEL: (852) 2406 5666

客戶服務中心 CUSTOMER SERVICE CENTRES

香港新界葵涌勝耀街2號信興中心1樓

1ST FLOOR, SHUN HING CENTRE, 2 SHING YIU STREET, KWAI CHUNG, NEW
TERRITORIES, HONG KONG

電話 TEL: (852) 2406 5439

傳真 FAX: (852) 2408 1389

澳門慕拉士大馬路193-199號南嶺工業大廈5樓I座

AVENIDA DE VENCESLAU DE MORAIS, NO. 193-199, 5 ANDAR-I, EDF. INDUSTRIAL
NAM LENG, MACAU

電話 TEL: (853) 2836 2928

傳真 FAX: (853) 2833 6405

有關最新之客戶服務中心資訊，請參閱信興服務中心網址：www.shesc.com或致電維修服務熱線查詢。

For the latest information of customer service centres, please visit www.shesc.com or call us at our hotline.