

Rasonic 樂信牌

抽濕機 Dehumidifier

型號：RPD-Y25HC

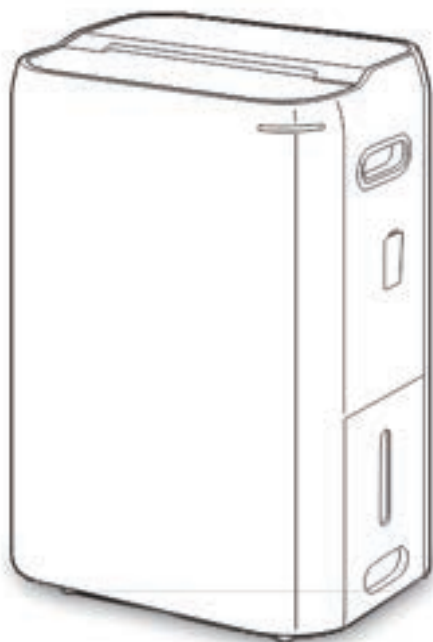

使用說明書 Instruction Manual

- 在使用本產品前，請先閱讀說明書，並妥善保存以備參考。

Please read this instruction manual before using the product and retain it for your future reference.

- 本手冊中的所有圖片僅供參考。

All the pictures in the manual are for reference only.

重要提示 IMPORTANT NOTE:

本設備使用R290  易燃製冷劑，在操作前請仔細閱讀本說明書。

This appliance is using R290  flammable refrigerant. Read this manual carefully before operating.

如需對本產品進行維修或保養，請聯絡樂信牌授權維修技術人員。

Contact Rasonic authorized service technician for repair or maintenance of this product.

目錄Index

安全注意事項	2-3
含有 R290 製冷劑的設備維修說明.....	4-10
使用環境	11
產品部件名稱	11-12
操作說明	13-18
連續排水功能	19
故障代碼	20
故障排除指南	20-21
產品規格	21
特別聲明	22
售後服務	22
Safety Warnings.....	24-25
Instruction for repairing appliances containing Refrigerant R290	26-34
Operation Conditions.....	34
Product Overview	35-36
Operating Introduction.....	36-40
Continuous Drainage Function	41
Error Code	42
Trouble Shooting	42
Specifications.....	43
Special Avowal	44
After Sales Service	44

安全注意事項



為確保您的安全，並減少受傷或觸電的風險，須遵守以下所有安全注意事項。

1. 須確保電源電壓正確 - 220-240 伏特/50 赫茲。
2. 本產品僅適用於室內使用。本產品旨在提供最佳性能，建議在環境溫度不超過 35°C 且不低於 5°C 的情況下使用。
3. 為了防止觸電，切勿將本產品放置在窗戶附近或浴室內。
4. 不要將機器放置在能產生高溫的家電附近，因為高溫可能損壞塑膠，及引起火災；也不要將機器在有爆炸性或腐蝕性環境中使用；也不要將機器在陽光下暴曬，以免外殼變形、變色。
5. 此設備可由 8 歲以上的兒童和體質、感覺或心智能力不足或是缺乏經驗與知識人士使用，但他們須了解其相關的風險。兒童不應把玩設備。不應由兒童獨自進行清潔與進行保養。
6. 把機器放在一個穩固，平坦的地面上使用，以防止產生振動和噪音。
7. 切勿在傾斜狀態下操作機器。一旦機器傾倒，應立即拔掉電源插頭。機器移動後，建議靜置最少 2 小時再使用。
8. 須確保機器四周留有 30 釐米的空間。

9. 確保進風口或出風口時常暢通無阻。

10. 不要將水噴灑到機器上，以免引起機器故障或觸電。

11. 手濕不要拔電源，以免觸電。



12. 拔出電源線插頭前要先關機，以免出現觸電或其他危險。

13. 若長時間不使用，應關機拔掉電源線插頭，以及倒掉水箱裡的水並擦拭乾淨。

14. 不要用力拉扯電源線，以免損壞電源線及造成其他危險。



15. 機器運行時，禁止將手指或其他物件插入進風口或出風口內，以防止損壞機器或造成受傷。

16. 清潔產品前，須關閉電源並拔出插頭，否則將會引致電擊或造成傷害。

17. 切勿飲用或使用回收水。回收水含有害物質會危害您的身體健康。

18. 若電源線受損，為避免危險，必須由信興電器服務中心有限公司進行更換。切勿自行拆卸機器、進行修理或調整。

使用 R290 製冷劑的家電附加警告

(請參閱銘牌確認使用的製冷劑類型)



使用本設備之前，請務必仔細閱讀本說明書。

- R290 製冷劑符合歐洲環保指令。本機器含有約 95 克 R290 製冷劑。
- 切勿刺破或燃燒本設備。
- 維護和維修必須在專門使用可燃性製冷劑的人員監督下進行並需要合格人員協助維護和維修。
- 任何參與冷凍迴路工作或維修的人員應持有業界認可的評估機構/製造商/代理商所頒發的有效證書，證明其具備安全處理製冷劑所需的資格。



含有 R290 製冷劑的設備維修說明

1. 現場檢查

在開始對含有可燃性製冷劑的系統進行維修之前，必須進行安全檢查，以確保將點燃風險降至最低。對於製冷系統的維修，必須在進行系統操作之前遵守以下預防措施。

作業程序

工作應在受控程序下進行，以最大程度地減少工作期間出現易燃氣體或蒸汽的風險。

2. 一般工作區域

所有維修人員和在當地工作的其他人員都應瞭解所進行工作的性質。應避免在密閉空間內工作。工作區周圍的區域應分隔開。通過控制易燃材料，確保該區域內的狀況安全。

3. 檢查是否有製冷劑

在工作之前和工作期間，應使用適當的製冷劑檢測器檢查該區域，以確保技術人員瞭解潛在的易燃環境。確保所使用的洩漏檢測設備適用於易燃製冷劑，即無火花、充分密封或本質安全。

4. 配備滅火器

如果對製冷設備或任何相關部件進行任何熱加工，應準備好合適的滅火設備。在充注區附近放置一個乾粉或二氧化碳滅火器

5. 無火源

任何人在可能暴露於含有或曾經含有易燃製冷劑的任何管道工程的製冷系統上執行操作時，不得以可能導致火災或爆炸風險的方式使用任何點火源。所有可能的火源，包括吸煙，都應遠離安裝、維修、拆卸和處置場所，在此期間，易燃製冷劑可能會釋放到周圍空間。在開始工作之前，應檢查設備周圍的區域，以確保沒有易燃危險或著火風險。應張貼“禁止吸煙”標誌。

6. 通風區域

在進入系統或進行任何高溫作業之前，必須確保工作區域是開放的，或通風良好。在工作期間，通風應持續進行。通風應能安全地分散任何釋放的製冷劑，最好是將其排放到外部大氣中。

7. 製冷設備檢查

更換電氣元件時，必須確保其符合要求並符合正確的規格。始終遵循製造商的維護和服務指南。如果有疑問，請諮詢製造商的技術部門尋求幫助。

對於使用可燃性製冷劑的安裝，需進行以下檢查：

---製冷劑充注量應符合安裝製冷劑相關部件的房間大小；

---通風設備和排氣口應正常運行且無阻塞；

8. 電氣設備檢查

電氣元件的維修和維護應包括初始安全檢查和元件檢查程序。如果存在可能危及安全的故障，則在妥善處理之前，不得將電源連接到電路。如果故障不能立即糾正，但需要繼續運行，則應採用適當的臨時解決方案。應將情況報告給設備所有者，以便通知所有各方。

初步安全檢查應包括：

- 確保電容器已放電；應以安全的方式進行，避免引發火花；
- 在充注、回收或排空系統時，沒有帶電的電氣元件和線路暴露在外；
- 確保接地連接持續有效。

9. 密封組件的維修

在修理密封元件過程中，在拆除密封蓋等之前，應將所有電源與正在工作的設備斷開。如果在維修過程中必須為設備供電，則最關鍵的點應有永久運行的洩漏檢測形式，以警告潛在的危險情況。

應特別注意以下事項，以確保在對電氣元件進行操作時，不會改變外殼從而影響防護等級，包括電纜損壞、連接數量過多、端子不符合原始規格、密封件損壞、壓蓋安裝不正確等。

確保密封件或密封材料未老化，以至於無法有效防止可燃性氣體進入。更換的零件應符合製造商的規格。

注意：使用矽膠密封劑可能會影響某些類型的洩漏檢測設備的有效性。本安組件在處理之前不必隔離。

10. 本安組件維修

請勿在電路上施加任何永久性電感或電容負載，除非確保不會超過所用設備的允許電壓和電流。

11. 佈線檢查

檢查佈線是否會受到磨損、腐蝕、過度壓力、振動、鋒利邊緣或任何其他不利環境因素的影響。

檢查還應考慮老化或持續洩漏的影響。不得使用鹵素燈（或任何其他使用明火的探測器）。

12. 可燃性製冷劑的檢測

在尋找或檢測製冷劑洩漏時，絕對不能使用任何潛在的火源。不得使用鹵化物火炬（或任何其

他使用明火的探測器)。

13. 洩漏檢測方法

以下洩漏檢測方法適用於含有可燃性製冷劑的系統：

應使用電子洩漏探測器檢測可燃性製冷劑，但其靈敏度可能不夠，或者需要重新校正。(檢測機器應在無製冷劑的區域進行校正。)確保探測器不是潛在的火源，並且適用於所使用的製冷劑。洩漏檢測設備應設置為製冷劑的LFL百分比，並應根據所使用的製冷劑和相應的氣體百分比(最多為25%)進行校正。

洩漏檢測液適用於大多數製冷劑，但應避免使用含氯的清潔劑，因為氯可能與製冷劑反應，腐蝕銅管道。

如果懷疑存在洩漏，應移除或熄滅所有明火。

如果發現冷媒洩漏而需要釵焊，應從系統回收所有製冷劑，或隔離(透過關斷閥)在遠離洩漏處的系統部分。

14. 拆卸和排空

當進入製冷劑回路進行維修或其他目的時，應遵循常規操作程式。然而，由於易燃性是一個考慮因素，必須遵循最佳操作規範。應嚴格按照以下程式進行操作：

移除製冷劑；

使用惰性氣體清洗迴路；

排空；

再次使用惰性氣體清洗；

通過切割或釵焊打開迴路；

製冷劑充填量應回收到正確的回收氣瓶中。系統應用氧氮混合氣(OFN)沖洗，確保機器安全。

此過程可能需要重複數次。不得使用壓縮空氣或氧氣進行此程序。

沖洗應是使用 OFN 破壞系統中的真空並繼續充填直到達到工作壓力，然後排放至空氣中，最後抽真空。此過程應重複，直到系統內沒有製冷劑為止。使用最終 OFN 充填時，應將系統排放至大氣壓力以便進行作業。如果要對管道進行釺焊作業，此操作絕對有必要。確保真空泵的出口未靠近任何點火源且通風良好

15. 充填程序

除常規充填程式外，還應遵循以下要求：

- 確保在使用充填設備時不會發生不同製冷劑的污染。管道或軟管應盡可能短，以儘量減少其中的製冷劑含量。
- 氣瓶應保持直立。
- 在充填製冷劑之前，確保製冷系統接地。
- 充填完成後，應對系統進行標記（如果尚未標記）。
- 在充填製冷劑時應特別小心，不得使製冷系統過度充注。

在重新充填系統之前，應使用氧氮混合氣（OFN）對系統進行壓力測試。系統應在充注完成後試運轉之前進行洩漏測試。離開現場前，應再次進行洩漏測試。

16. 停用

在執行此程式之前，技術人員必須完全熟悉設備及其所有細節。建議的良好做法是確保所有製冷劑安全回收。執行此任務之前，應取得油和製冷劑樣本，以防在重複使用回收的製冷劑前需要分析。

確保在開始程序之前電源已連接。

- a) 熟悉設備及其操作。
- b) 斷開系統電源。
- c) 在進行操作之前，確保以下事項：

可正確使用機械搬運設備；回收過程應始終由合格的人員進行監督；回收設備和氣瓶符合相應標準。

- d) 如果可能，請將製冷系統抽成真空。
- e) 如果無法抽真空，請製作歧管，以便從系統各個部分排出製冷劑。
- f) 在回收之前，確保氣瓶置於秤上。
- g) 啟動回收機器，並按照製造商的說明操作。
- h) 請勿過度填充氣瓶（不超過 80% 容積液體填充量）。
- i) 即使是暫時性的，也不得超過氣瓶的最大工作壓力。
- j) 當氣瓶已正確填充且回收過程完成後，務必確保氣瓶和設備及時從現場移除，並關閉設備上的所有隔離閥門。
- k) 回收的製冷劑在未經過清潔和檢查之前不得充注到其他製冷系統中。

17. 標示

設備應貼上標籤，注明已停用並且已排空製冷劑。標籤應注明日期並簽名。確保設備上有標籤，說明設備內含可燃製冷劑。

18. 回收

在從系統中移除製冷劑時，無論是為維修還是停用，建議將所有製冷劑回收至氣瓶中，並確保僅使用適當的製冷劑回收氣瓶。確保有足夠數量的氣瓶來容納系統的總充注量。所有使用的氣瓶應標明用於回收製冷劑，並注明該製冷劑（即專門用於回收製冷劑的氣瓶）。氣瓶應配有壓力釋放閥和相關的切斷閥，並確保其處於良好的工作狀態。空的回收氣瓶應進行抽空，並在回收前盡可能冷卻。

回收設備應處於良好工作狀態，配備相關使用說明，並且應適合回收易燃製冷劑。

此外，應提供一套校準過的計重秤，並確保其正常工作。軟管應配備無洩漏的分離式接頭，並

保持良好狀態。在使用回收機器之前，檢查其是否處於正常的運作狀態，是否進行了適當的維護，並且所有電氣元件都應密封，以防止在製冷劑洩漏時引發火災。如有疑問，請諮詢製造商。

回收的製冷劑應退回給製冷劑供應商，使用正確的回收氣瓶，並安排相關的廢棄物轉運單。請勿在回收單元中混合製冷劑，特別是不要將其混合在氣瓶中。

如果需要移除壓縮機或壓縮機油，應確保已將其抽空至可接受的程度，確保易燃製冷劑不再殘留在潤滑油中。抽空過程應在將壓縮機退回供應商之前完成。只能採用對壓縮機本體進行電加熱來加快此過程。從系統排油時，應以安全的方式進行。

19. 含易燃製冷劑設備的運輸

依據當地法規執行。

20. 廢棄設備含易燃製冷劑

請參照國家法規。

21. 機器/家電的存儲

設計的存儲應按照製造商的說明進行。

22. 存儲未售出的包裝設備

包裝存儲保護應構建得當，確保設備在包裝內不受機械損害，避免製冷劑洩漏。

允許一起存儲的設備數量將由當地法規決定。

23. 棄置設備



該標記表明該產品不應與其他生活垃圾一起處理。為了防止不受控制的廢棄物處置可能對環境或人類健康造成危害，負責任地回收廢棄物，以促進物質資源的可持續再利用。若要退回您用過的設備，請使用退貨和收集系統或聯絡購買

該產品的零售商。他們可以將該產品進行環保回收。

除濕機是受管制電氣設備（REE）之一，其處置應遵循當地法規。

使用環境

1. 工作環境：

環境溫度：5°C-35°C

環境濕度：35%RH-90%RH

2. 本設備僅限室內使用，如客廳或臥室。切勿在潮濕環境或戶外使用。

3. 使用本設備前，應確保所以門窗已關閉，以達到最高效率

4. 確保設備放置在平穩的地面上。如果地面不穩，可能導致設備傾斜，從而產生過度震動、噪音及水洩漏等問題。

產品部件名稱

前視圖

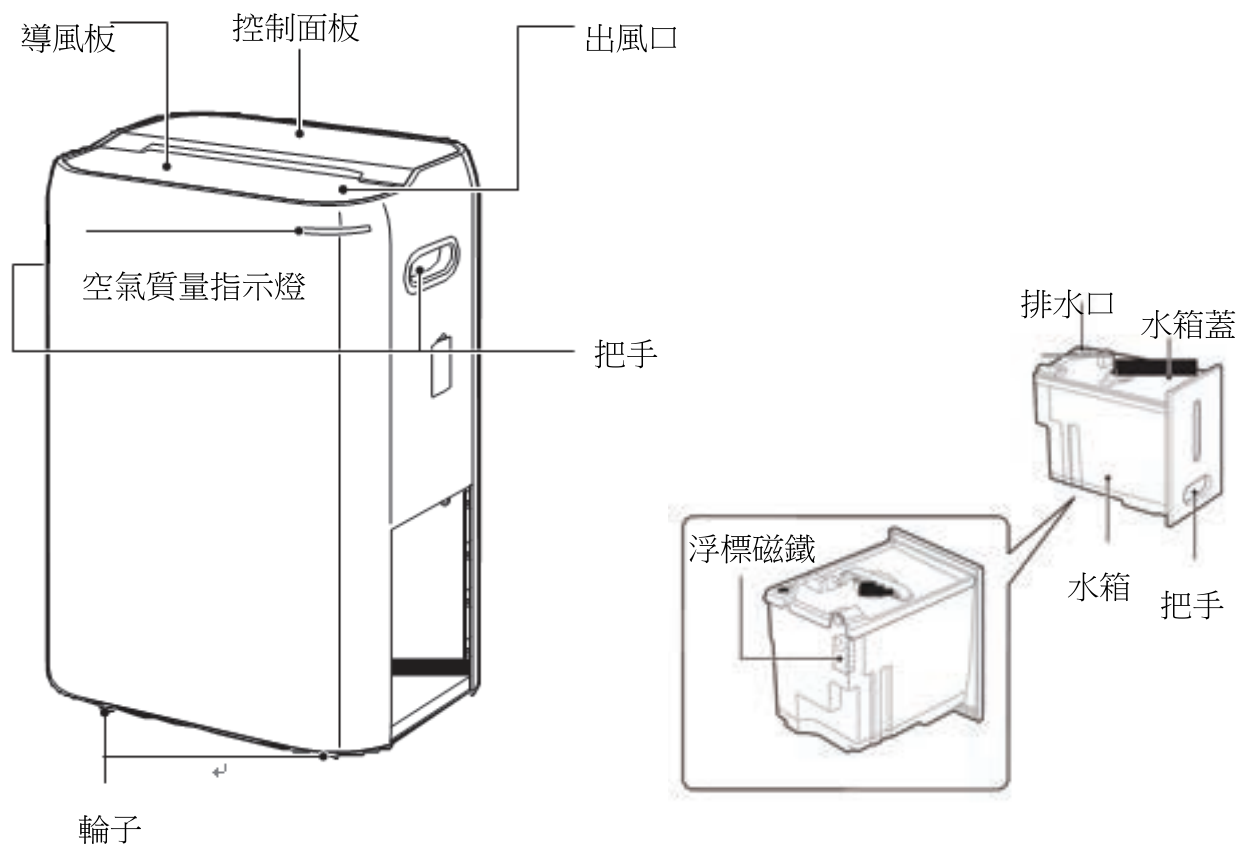

後視圖

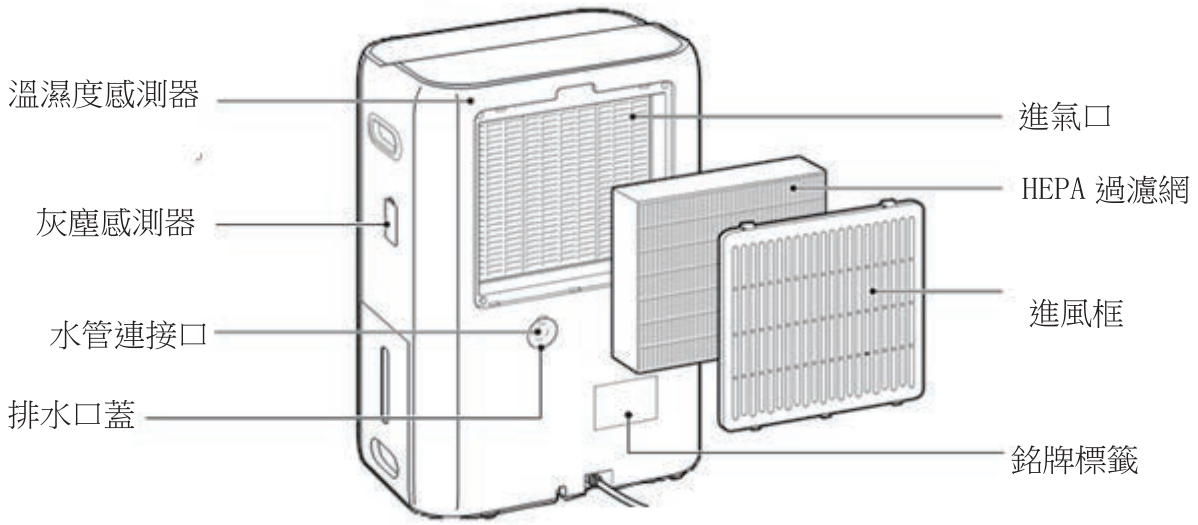

出風口

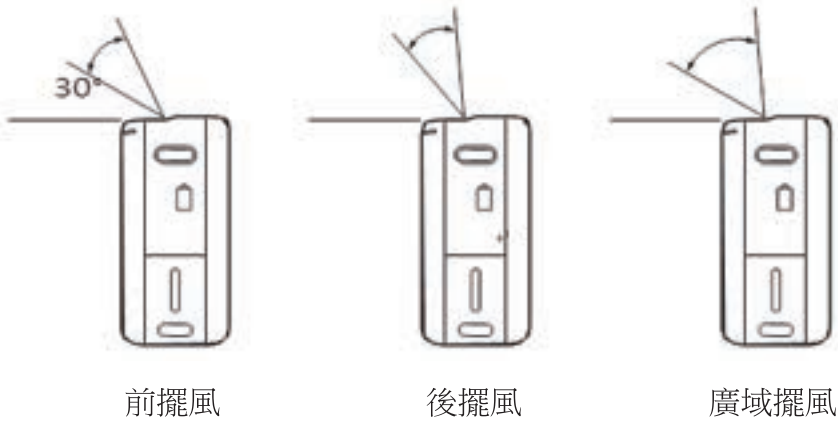
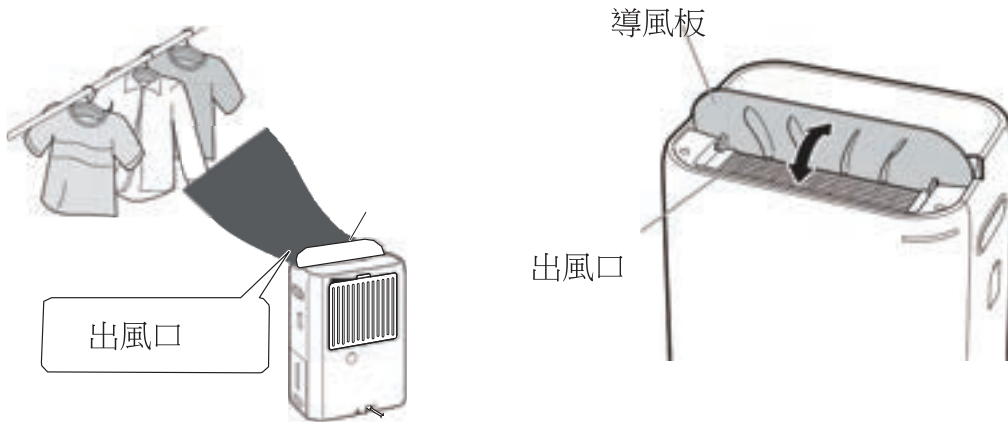

操作說明

(1) 控制面板







(2) 按鍵功能與名稱

-  電源鍵：用於啟動或關閉設備。按下此鍵，設備進入運行狀態或待機狀態。
-  模式鍵：切換不同運行模式（如自動除濕、連續除濕、衣類乾燥或空氣清淨）。
-  風速鍵：按下此鍵可設置風速，包括弱檔、強檔和自動模式。
-  風向鍵：按下此鍵可設置出風口的擺動範圍（前擺風/後擺風/廣域擺風）。
-  濕度/時間設定 濕度/定時設置鍵：按下此鍵可調節濕度設置範圍（RH40%至 RH70%）或定時時間設置（0 小時至 12 小時）。
-  定時功能 定時/童鎖鍵：設置關機時間（0 小時至 12 小時）。長按 2 秒可開啟或關閉童鎖功能。
-  內部乾燥 內部乾燥鍵：按下此鍵可啟動或關閉內部乾燥功能。長按 2 秒可預約內部乾燥功能。
- 除霜** 除霜指示燈：當除霜功能運作時，機器會點亮指示燈。
- 滿水** 水滿指示燈：當水箱充滿水時，機器會點亮指示燈。

(3) 設定 12 小時自動關機功能

機器默認啟動 12 小時自動關機功能，連續運行 12 小時後會自動關機（在 12 小時計時過程中，每當輕觸按鍵一次，將重新計時 12 小時）

如需要機器連續運行，請變更設定：

1. 機器在待機情況下，同時按住  +  2 秒鐘，蜂鳴器會發出‘嗶’一聲，機器進入「自動關機」設置模式；
2. 輕觸  可切換選擇啟動或關閉「自動關機」功能。
 - 啟動『自動關機』時，「預約」指示燈閃爍；
 - 關閉『自動關機』時，「乾燥中」指示燈閃爍；
3. 輕觸  蜂鳴器會發出‘嗶’一聲，內部乾燥指示燈亮起 3 秒後熄滅，即完成 12 小時自動關機「啟動」或「關閉」功能設定。
 - 在變更設定過程中，如沒有輕觸  則不會保存設定。

(4) 指示燈說明

當水箱滿時，指示燈會亮起紅色；否則，指示燈關閉。

空氣質量指示燈

空氣質量指示燈根據灰塵的多寡以五種顏色顯示：淺藍色、綠色、黃色、橙色和紅色，具體說明如下：

淺藍色	綠色	黃色	橙色	紅色
優秀	良好	中等	較差	很差

在設備運行的第 1 分鐘內，無論空氣品質如何，指示燈會顯示淺藍色。

水箱:

大約每月清洗一次，或當出現異味或污垢時清洗。

1. 從機器中取出水箱。

2. 握住水箱蓋兩側向上拉起，取下水箱蓋。

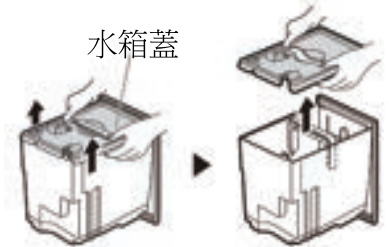

3. 用清水清潔水箱和水箱蓋。

對於難以清除的污垢，可使用軟刷和稀釋的中性廚房清潔劑進行清洗，徹底沖洗乾淨以避免殘留。

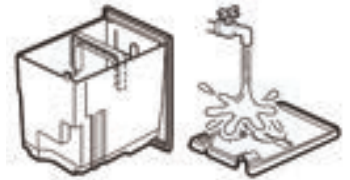

4. 將水箱蓋重新安裝到水箱上。

確保安裝牢固以避免留有縫隙。

注意事項: 未安裝水箱蓋使用機器可能導致內部水溢出，弄濕家具等。

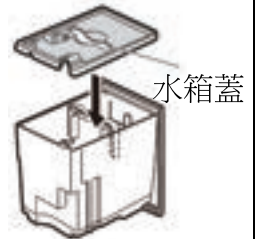

5. 將水箱重新安裝到機器中。

當磁鐵脫落時，請根據圖示將其按照正確的位置和方向重新安裝。檢查浮標中是否混入異物或雜質，否則可能導致無法檢測水滿狀態，從而引發溢水問題。

• 切勿移除水箱浮標&磁鐵。如其脫落，務必重新安裝。

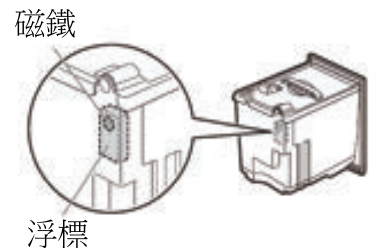

當機器處於除霜狀態時，指示燈亮起（白色）。當不在除霜功能狀態時，指示燈熄滅。

(5) 清潔機器:

- 使用濕潤的海綿擦拭機器表面，隨後用乾淨的軟布擦乾。
- 避免使用酒精或含有溶劑的清潔產品。
- 切勿將機器浸入水中清洗。

(6) 清潔進風框:

進風框用於過濾空氣中的灰塵和雜質。如果進風框被灰塵堵塞，會影響機器性能，增加能耗，可能導致機器過熱甚至引發火災。在正常使用情況下，建議每兩周清潔一次進風框，以保持良好的抽濕效果。關閉機器電源並拔下插頭。取下進風框，使用軟刷或濕布輕輕清潔灰塵和雜質。確保清潔後進風框完全乾燥，再將其重新安裝到機器上。

拆卸進風框

將進風框的上端向前拉起，然後向上提起將其拆下。



安裝進風框

將進風框下方的三個卡扣插入機器中。然後將進風框直接按壓到機器上進行安裝。請務必確保上下卡扣均插入機器的對應孔位中。

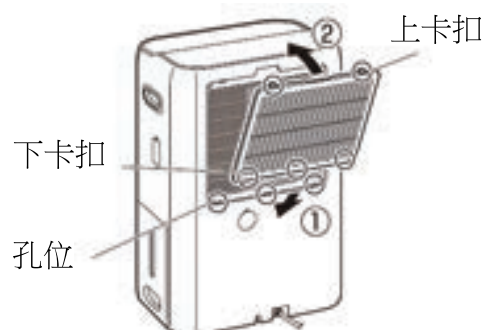

吸塵後，將其取下，用清水清洗，並置於乾燥處徹底晾乾。

- 如果污垢較嚴重，請使用軟刷和中性廚房清潔劑清洗。將清潔劑徹底沖洗乾淨，避免殘留，然後置於乾燥處徹底晾乾。

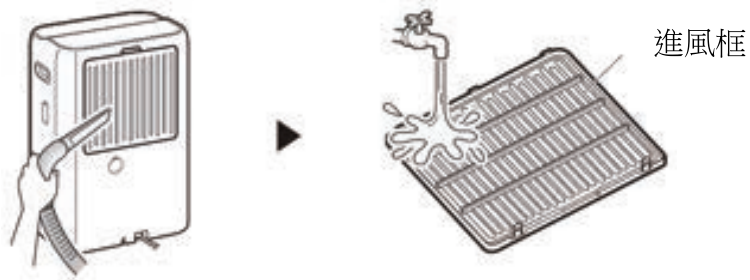

(7) HEPA 過濾網 (濾網型號: RPD-Y/HEPA)

HEPA 過濾網大約每一年更換一次。

- 不可使用吸塵器清潔或用水沖洗。
- 當過濾網損壞或出現孔洞時，灰塵會穿過過濾網，導致集塵性能下降。
- 在空氣污濁的環境中使用時，過濾網的更換間隔會縮短。當過濾網開始失去效果時，應及時更換。

更換 HEPA 過濾網

1. 拆卸進風框

• 抓住進風框的上端，將其向前拉出。然後向上提起，將進風框完全取下。

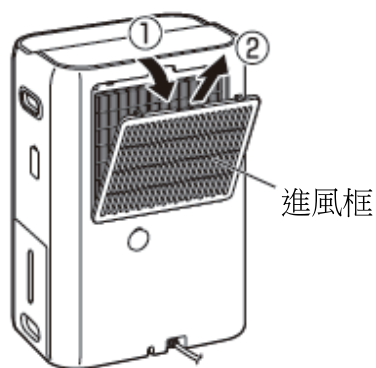

2. 拆卸 HEPA 過濾網

• 抓住 HEPA 過濾網下方的拉手，將其向前拉出。將過濾網完全取下。

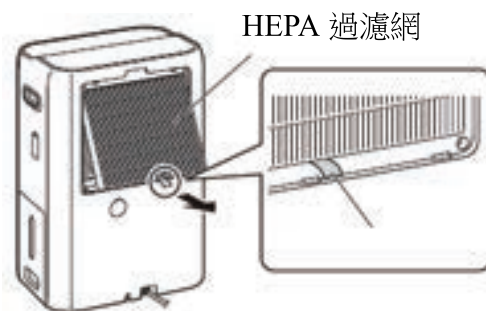

3. 安裝新的 HEPA 過濾網

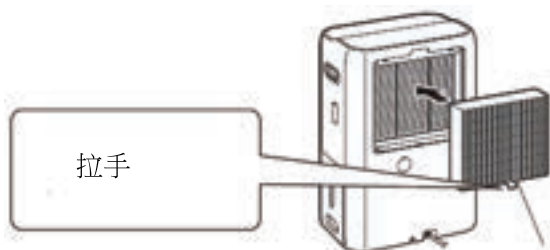

4. 記錄使用年份/月份

(8) 灰塵感測器:

灰塵感測器鏡頭約每 3 個月擦拭一次。

1. 取下感測器進氣口蓋。
2. 使用乾燥的棉花棒沿內部左側輕輕擦拭。
3. 使用吸塵器的縫隙吸嘴清除周圍的灰塵。
4. 確保蓋子蓋好。(否則會導致操作不正確)

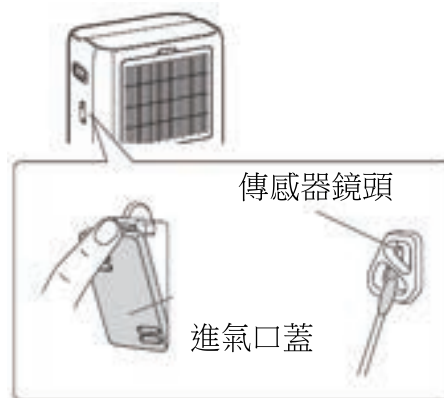

連續排水功能

當抽濕機需要連續排水時，拔出排水孔塞子，將內徑為 12mm 的排水軟管* 連接到後殼的排水口。當抽濕機連續運行時，水將通過排水軟管排出，水箱不會儲水，機器可以連續運行，不會因水箱滿水而停止。

在連續排水過程中，排水軟管必須平放在地面上。排水軟管不能彎曲或翹起，否則水無法順暢流出，甚至無法流動。

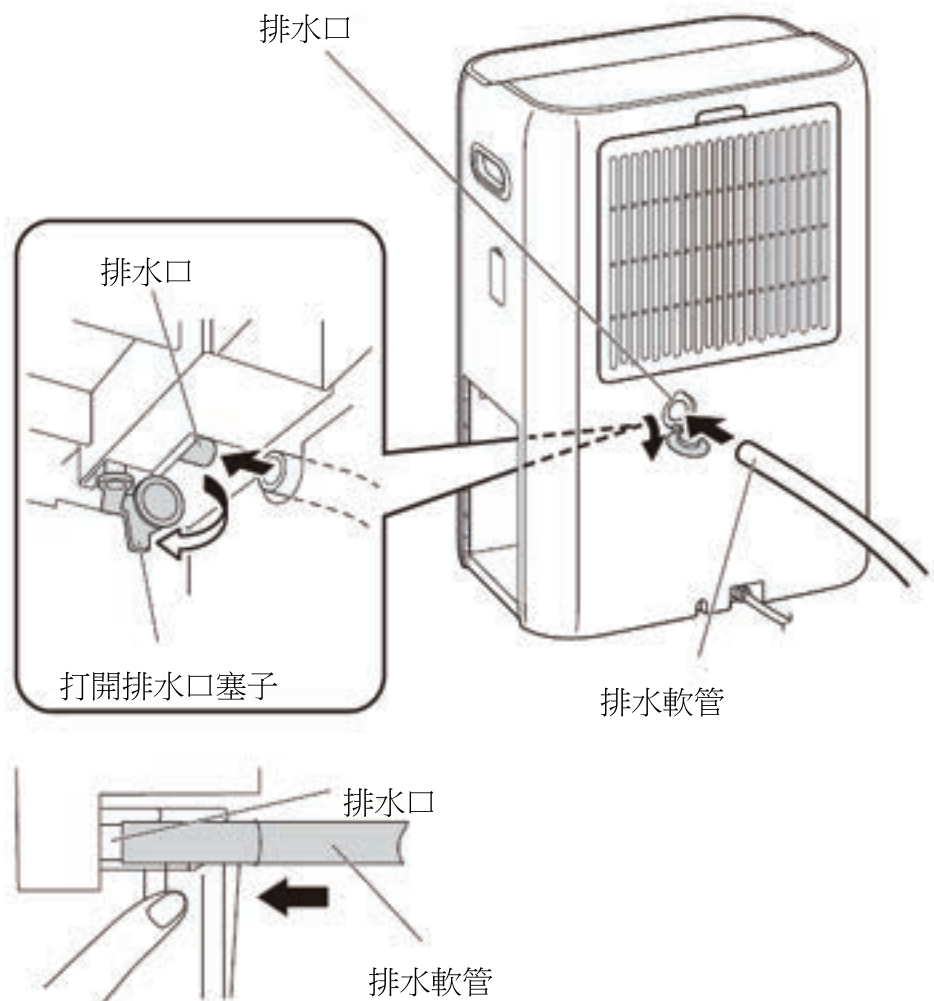

*排水軟管需自行購買。

故障代碼

部件	條件	故障代碼
光電傾倒開關	機器傾斜 45°	A0
環境溫度傳感器 NTC	環境溫度 $\leq 0^{\circ}\text{C} / \geq 40^{\circ}\text{C}$	C9
濕度傳感器	開路	Lo
濕度傳感器	短路	Hi
除霜溫度傳感器	開路/短路	C4
NTC	NTC $\geq 40^{\circ}\text{C}$	C4
製冷劑洩漏	製冷劑洩漏	U0
主馬達	馬達堵塞/開路	A6

故障排除指南

在聯繫技術支援之前，請檢查以下項目：

問題	檢查清單
機器無法運行	<input type="checkbox"/> 確保電源插頭已完全插入插座中。 <input type="checkbox"/> 檢查抽濕機是否已達到設定濕度，或水箱是否已滿。 <input type="checkbox"/> 確認水箱是否放置正確。
抽濕效果不佳	<input type="checkbox"/> 確保機器已運行足夠時間以去除濕氣。 <input type="checkbox"/> 檢查進風口或出風口是否有障礙物阻擋。 <input type="checkbox"/> 環境濕度可能低於設定濕度。 <input type="checkbox"/> 確保所有門窗及其他開口已完全關閉。 <input type="checkbox"/> 室內溫度可能過低，低於 5°C (41°F)。

噪音過大	<input type="checkbox"/> 確保機器放置在穩定、平整的表面上。 <input type="checkbox"/> 定期清潔進風框。
------	---

如遵從以上方法處理仍然無法解決問題，應立即停止使用並聯絡信興電器服務中心有限公司進行檢查及維修。

產品規格

參數	說明
型號	RPD-Y25HC
額定電壓及頻率	220-240 伏特 ~ 50 赫茲
抽濕量	25 升/每日 (30°C, 80%RH) 14.5 升/每日 (26.7°C, 60%RH)
消耗功率	260W (26.7°C, 60%RH)
製冷劑	R290 (95 克)
水箱容量	3.7 升
產品尺寸(闊 x 深 x 高)	376 x 271 x 578 mm
重量	14.6 公斤

特別聲明

1. 本資料上所有內容經過認真核對，如有任何印刷及內容上的誤解，本公司將保留解釋權。
2. 本產品若有技術改進，會編進新版說明書中，恕不另行通知；產品外觀及顏色如有改動，則以實物為準。
3. 使用說明書的電子副本可以通過電子郵件發送致客戶。如有需要，請致電信興電工工程有限公司：2861 2767。

售後服務

由購買日期起之一年保修期內，經信興電器服務中心有限公司之服務人員證實乃在正常使用之情況下發生者，本公司將提供免費修理及更換零件。經更換之任何損壞零件，將歸屬本公司。保修範圍不包括修理或更換產品之附件、外接線、水箱或機殼等，如有需要服務時，用戶須另付費用。

用戶請於維修時出示購買收據 / 換購收據及保修證，如有任何疑問，請致電信興電器服務中心有限公司熱線查詢：2406 5666。

如在保修證內所列之電器：1)曾經被非本公司技術人員明顯地或非明顯地進行改裝、更改或修理；或 2)曾經被錯誤或不適當或疏忽使用、或因液體浸蝕、水濺、不正常供電、天災、意外或外來因素造成損壞；或 3)並非安裝在陸上固定地點；或 4)不當安裝位置影響正常操作；或 5)非工商業用型號產品，被用作工商業用途；或 6)用戶搬遷地址或更換物主而未能及時通知信興電器服務中心有限公司者，本保修證將自動失效。



信興電工工程有限公司

SHUN HING ELECTRIC WORKS & ENGINEERING CO., LTD

辦公室: 香港九龍尖沙咀東部麼地道 67 號半島中心 9 樓

OFFICE: 9/F, PENINSULA CENTRE, 67 MODY ROAD, TSIMSHATSUI EAST, KOWLOON, HONG KONG

電話 TEL: (852) 2861 2767 傳真 FAX: (852) 2865 6706

網址 WEBSITE: www.rasonic.hk 電郵 EMAIL: shew@shunhinggroup.com

保養及維修 MAINTENANCE AND REPAIR SERVICE

信興電器服務中心有限公司

SHUN HING ELECTRIC SERVICE CENTRE LTD.

辦公室: 香港新界葵涌勝耀街 2 號信興中心 11 樓

OFFICE: 11TH FLOOR, SHUN HING CENTRE, 2 SHING YIU STREET, KWAI CHUNG, NEW TERRITORIES, HONG KONG

電話 TEL: (852) 2406 5666

傳真 FAX: (852) 2408 0316

網址 WEBSITE: www.shesc.com

消耗品/附件銷售熱線 CONSUMABLES/ ACCESSORIES SALES HOTLINE

電話 TEL: (852) 2406 5666

客戶服務中心 CUSTOMER SERVICE CENTRES

香港新界葵涌勝耀街 2 號信興中心 1 樓

1ST FLOOR, SHUN HING CENTRE, 2 SHING YIU STREET, KWAI CHUNG, NEW TERRITORIES, HONG KONG

電話 TEL: (852) 2406 5439

傳真 FAX: (852) 2408 1389

澳門慕拉士大馬路 193-199 號南嶺工業大廈 5 樓 I 座

AVENIDA DE VENCESLAU DE MORAIS, NO. 193-199, 5 ANDAR-I, EDF. INDUSTRIAL NAM LENG, MACAU

電話 TEL: (853) 2836 2928

傳真 FAX: (853) 2833 6405

有關最新之客戶服務中心資訊, 請參閱信興服務中心網址 www.shesc.com 或致電維修服務熱線查詢。

For the latest information of customer service centres, please visit www.shesc.com or call us at our hotline.

RPD/YL/2412

Safety Warnings



For your continued safety and to reduce the risk of injury or electric shock, please follow all the safety warnings listed below.

1. Please be sure your electricity is correct—220-240V/50Hz.
2. This appliance is for indoor use only. The appliance is designed to provide an optimum performance not recommended to operate in ambient temperatures exceeding 35°C or lower than 5°C.
3. To protect against electrical shock, do not place it near the window or in the bathroom.
4. Please ensure the unit is positioned away from high-temperature appliances to prevent plastic damage and fire hazards. Do not operate the unit in explosive or corrosive environments. Do not use in places exposed to direct sunlight to avoid deform and discolor.
5. This appliance is suitable for use by children aged 8 years and older, as well as individuals with reduced physical, sensory, or mental capabilities or those lacking experience and knowledge, provided they have received proper supervision or instruction on safe usage and understand associated hazards. Children should not play with the appliance, and any cleaning or user maintenance tasks should be supervised when performed by children.
6. Operate this unit on a flat surface to minimize vibration and noise.
7. Do not operate the unit when tilted. If the unit is toppled over, immediately unplug it. After moving the unit, it is recommended to let it sit for 2 hours before using it again.

8. Ensure a clear space of 30 cm on all sides of the unit.
9. Ensure that both the inlet and outlet ventilation always remain unobstructed.
10. Avoid spraying water on the unit, as it may lead to malfunctioning and electric shock hazards.

11. Never pull the socket by using damp hands, otherwise, it may cause electric shock.



12. Always switch off the unit before unplugging to prevent electric shock or arcing.

13. When the unit is not used for an extended period, remember to switch off, unplug, and empty the water reservoir.

14. Do not pull the power cable forcefully, as it may cause damage.



15. Never insert fingers or any other objects into the unit's openings.

16. Before cleaning, turn off the power and unplug the unit. Otherwise, it may cause electric shock or injury.

17. Do not drink or use the water drained from the unit. It contains contaminants and could make you sick.

18. If the supply cord is damaged, it must be replaced by Shun Hing Electric Service Centre Ltd. in order to avoid hazard. Never disassemble the unit, try to carry out repairs, or adjust the unit yourself.

Additional warnings for appliances with R290 refrigerant (refer to the rating label for the type of refrigerant used)



READ THE TECHNICAL MANUAL CAREFULLY BEFORE USING THE APPLIANCE

- R290 refrigerant complies with European environmental directives. This appliance contains approximately 95g of R290 refrigerant.
- Do not pierce or burn the appliance.
- Maintenance and repairs requiring the assistance of other qualified personnel must be carried out under the supervision of specialists in the use of inflammable refrigerants.
- Any person who is involved with working on or repairing refrigerating circuits should possess a valid certificate issued by industry-recognized assessment organizations/manufacturer/agent certifying that they have the necessary qualifications required for handling refrigerants safely.



INSTRUCTION FOR REPAIRING APPLIANCES CONTAINING Refrigerant R290

1. Checks to the area

Prior to beginning work on systems containing flammable refrigerants, safety checks are necessary to ensure that the risk of ignition is minimized. For repair to the refrigerating system, the following precautions shall be complied with prior to conducting work in the system.

Work procedure

Work shall be undertaken under a controlled procedure so as to minimize the risk of a flammable gas or vapor being present while the work is being performed.

2. General work area

All maintenance staff and others working in the local area shall be instructed on the nature of work being carried out. Work in confined spaces shall be avoided. The area

around the workspace shall be sectioned off. Ensure that the conditions within the area have been made safe by control of flammable material.

3. Checking for presence of refrigerant

The area shall be checked with an appropriate refrigerant detector prior to and during work, to ensure the technician is aware of potentially flammable atmospheres. Ensure that the leak detection equipment being used is suitable for use with flammable refrigerants, i.e. nonspeaking, adequately sealed or intrinsically safe.

4. Presence of fire extinguisher

If any work is to be conducted on the refrigeration equipment or any associated parts, appropriate fire extinguishing equipment shall be available to hand. Have a dry powder or CO₂ fire extinguisher adjacent to the charging area.

5. No ignition sources

No person carrying out work in relation to a refrigeration system which involves exposing any pipe work that contains or has contained flammable refrigerant shall use any sources of ignition in such a manner that it may lead to the risk of fire or explosion. All possible ignition sources, including cigarette smoking, should be kept sufficiently far away from the site of installation, repairing, removing and disposal, during which flammable refrigerant can possibly be released to the surrounding space. Prior to work taking place, the area around the equipment is to be surveyed to make sure that there are no flammable hazards or ignition risks. **"No Smoking"** signs shall be displayed.

6. Ventilated area

Ensure that the area is in the open or that it is adequately ventilated before breaking into the system or conducting any hot work. A degree of ventilation shall continue during the period that the work is carried out. The ventilation should safely disperse any released refrigerant and preferably expel it externally into the atmosphere.

7. Checks to the refrigeration equipment

Where electrical components are being changed, they shall be fit for the purpose and

to the correct specification. At all times the manufacturer's maintenance and service guidelines shall be followed. If in doubt consult the manufacturer's technical department for assistance.

The following check shall be applied to installations using flammable refrigerants:

--the charge size is in accordance with the room size within which the refrigerant containing parts are installed;

--the ventilation machinery and outlets are operating adequately and are not obstructed;

8. Checks to electrical devices

Repair and maintenance to electrical components shall include initial safety checks and component inspection procedures. If a fault exists that could compromise safety, then no electrical supply shall be connected to the circuit until it is satisfactorily dealt with. If the fault cannot be corrected immediately but it is necessary to continue operation, an adequate temporary solution shall be used. This shall be reported to the owner of the equipment so all parties are advised.

Initial safety checks shall include;

--that capacitors are discharged; this shall be done in a safe manner to avoid possibility of sparking;

--that there no live electrical components and wiring are exposed while charging, recovering or purging the system;

--that there is continuity of earth bonding.

9. Repairs to sealed components

During repairs to sealed components, all electrical supplies shall be disconnected from the equipment being worked upon prior to any removal of sealed covers, etc. If it is absolutely necessary to have an electrical supply to equipment during servicing, then a permanently operating form of leak detection shall be located at the most critical point to warn of a potentially hazardous situation.

Particular attention shall be paid to the following to ensure that by working in

electrical components, the casing is not altered in such a way that level of protection is affected. This shall include damage to cables, excessive number of connection, terminals not made to original specification, damage to seals, incorrect fitting of glands, etc.

Ensure that seals or sealing materials have not degraded such that they no longer serve the purpose of preventing the ingress of flammable atmospheres. Replacement parts shall be in accordance with the manufacturer's specifications,

NOTE: The use of silicon sealant may inhibit the effectiveness of some types of leak detection equipment. Intrinsically safe components do not have to be isolated prior to working on them.

10. Repair to intrinsically safe components

Do not apply any permanent inductive or capacitance loads to the circuit without ensuring that this will not exceed the permissible voltage and current permitted for the equipment in use.

11. Cabling

Check that cabling will not be subject to wear, corrosion, excessive pressure, vibration, sharp edges or any other adverse environmental effects. The check shall also take into account the effects of aging or continual leaks. A halide torch (or any other detector using a naked flame) shall not be used

12. Detection of flammable refrigerants

Under no circumstances shall potential sources of ignition be used in the searching for or detection of refrigerant leaks. A halide torch (or any other detector using a naked flame) shall not be used.

13. Leak detection methods

The following leak detection methods are deemed acceptable for systems containing flammable refrigerants.

Electronic leak detectors shall be used to detect flammable refrigerants, but the sensitivity may not be adequate, or may need re-calibrated. (Detection equipment shall be calibrated in a refrigerant-free area.) Ensure that the detector is not a potential source of ignition and is suitable for the refrigerant used. Leak detection equipment

shall be set at a percentage of the LFL of the refrigerant and shall be calibrated to the refrigerant employed and the appropriate percentage of gas (25% maximum) is confirmed.

Leak detection fluids are suitable for use with most refrigerants but the use of detergents containing chlorine shall be avoided as the chlorine shall be avoided as the chlorine may react with the refrigerant and corrode the copper pipe work.

If a leak is suspected, all naked flames shall be removed/extinguished.

If a leakage of refrigerant is found which requires brazing, all of the refrigerant shall be recovered from the system, or isolated (by means of shut off valves) in a part of the system both before and during the brazing process.

14. Removal and evacuation

When breaking into the refrigerant circuit to make repairs- or for any other purpose – conventional procedures shall be used. However, it is important that best practice is followed since flammability is a consideration. The following procedure shall be adhered to:

remove refrigerant;

purge the circuit with inert gas;

evacuate;

purge again with inert gas;

open the circuit by cutting or brazing;

The refrigerant charge shall be recovered into the correct recovery cylinders. The system shall be “flushed” with OFN to render the unit safe. This process may need to be repeated several times. Compressed air or oxygen shall not be used for this task. Flushing shall be achieved by breaking the vacuum in the system with OFN and continuing to fill until the working pressure is achieved, then venting to atmosphere, and finally pulling down to a vacuum. This processing shall be repeated until no refrigerant is within the system. When the final OFN charge is used, the system shall be vented down to atmospheric pressure to enable work to take place. This operation is absolutely vital if brazing operations on the pipe-work are to take place. Ensure that

the outlet for the vacuum pump is not close to any ignition sources and there is ventilation available.

15. Charging procedures

In addition to conventional charging procedures, the following requirements shall be followed.

-Ensure that contamination of different refrigerants does not occur when using charging equipment. Hoses or lines shall be as short as possible to minimize the amount of refrigerant contained in them.

-Cylinders shall be kept upright.

-Ensure that the refrigeration system is earthed prior to charging the system with refrigerant.

-label the system when charging is complete (if not already)

-Extreme care shall be taken not to overfill the refrigeration system.

Prior to recharging the system is shall be pressure tested with OFN. The system shall be leak tested on completion of charging but prior to commissioning. A follow up leak test shall be carried out prior to leaving the site.

16. Decommissioning

Before carrying out this procedure, it is essential that the technician is completely familiar with the equipment and all its detail. It is recommended good practice that all refrigerants are recovered safely. Prior to the task being carried out, an oil and refrigerant sample shall be taken is case analysis is required prior to re-use of reclaimed refrigerant. It is essential that electrical power is available before the task is commenced.

- a) become familiar with the equipment and its operation.
- b) Isolate system electrically.
- c) Before attempting the procedure ensure that;

Mechanical handling equipment is available and being used correctly; the recovery process is supervised at all times by a competent person; recovery equipment and cylinders conform to the appropriate standards.

- d) Pump down refrigerant system, if possible.
- e) If a vacuum is not possible, make a manifold so that refrigerant can be removed from various parts of the system.
- f) Make sure that cylinder is situated on the scales before recovery takes place.
- g) Start the recovery machine and operate in accordance with manufacturer's instructions.
- h) Do not overfill cylinders. (No more than 80% volume liquid charge).
- i) Do not exceed the maximum working pressure of the cylinder, even temporarily.
- j) When the cylinders have been filled correctly and the process completed, make sure that the cylinders and the equipment are removed from site promptly and all isolation valves on the equipment are closed off.
- k) Recovered refrigerant shall not be charged into another refrigeration system unless it has been cleaned and checked.

17. Labeling

Equipment shall be labeled stating that it has been de-commissioned and emptied of refrigerant. The label shall be dated and signed. Ensure that there are labels on the equipment stating the equipment contains flammable refrigerant.

18. Recovery

When removing refrigerant from a system, either for servicing or decommissioning, it is recommended good practice that all refrigerant into cylinders, ensure that only appropriate refrigerant recovery cylinders are employed. Ensure that the correct number of cylinders for holding the total system charge are available. All cylinders to be used are designated for the recovered refrigerant and labeled for that refrigerant (i.e special cylinders for the recovery of refrigerant). Cylinders shall be complete with pressure relief valve and associated shut-off valves in good working order. Empty recovery cylinders are evacuated and, if possible, cooled before recovery occurs. The recovery equipment shall be in good working order with a set with a set of instructions concerning the equipment that is at hand and shall be suitable for the recovery of flammable refrigerants.

In addition, a set of calibrated weighing scales shall be available and in good working

order. Hoses shall be complete with leak-free disconnect couplings and good condition. Before using the recovery machine, check that it is in satisfactory working order, has been properly maintained and that any associated electrical components are sealed to prevent ignition in the event of a refrigerant release. Consult manufacturer of in doubt. The recovered refrigerant shall be returned to the refrigerant supplier in the correct recovery cylinder, and the relevant Waste Transfer Note arranged. Do not mix refrigerants in recovery units and especially not in cylinders.

If compressors or compressor oils are to be removed, ensure that they have been evacuated to an acceptable level to make certain that flammable refrigerant does not remain within the lubricant. The evacuation process shall be carried out prior to returning the compressor to the suppliers. Only electric heating to the compressor body shall be employed to accelerate this process. When oil drained from a system, it shall be carried out safely.

19. Transport of equipment containing flammable refrigerants

Determined by local regulations.

20. Discarded appliances supplies flammable refrigerants

See National Regulations.

21. Storage of equipment/appliances

The storage of equipment should be in accordance with the manufacturer's instructions.

22. Storage of packed (unsold) equipment

Storage package protection should be constructed such that mechanical damage to the equipment inside the package will not cause a leak of the refrigerant charge.

The maximum number of pieces of equipment permitted to be stored together will be determined by local regulations.

23. Disposal of equipment



This marking indicates that the product should not be disposed with other household wastes. To prevent possible harm to the environment or human health from uncontrolled waste disposal, recycle it responsibly to

promote the sustainable reuse of material resources. To return your used device, please use the return and collection systems or contact the retailer where the product was purchased. They can take this product for environmentally safe recycling.

Dehumidifier is one of the regulated electrical equipment (REE), its disposal shall follow local regulation.

Operation Conditions

1. Working conditions:

Ambient temperature: 5°C -35°C.

Ambient humidity: 35%RH-90%RH.

2. This device is intended for indoor use only, such as in living rooms or bedrooms.

Never use it in wet environments or outdoors.

3. For optimal efficiency and energy savings, close doors and windows before activating the unit.

4. Ensure the unit is positioned on a stable and flat floor surface. If the floor surface is unstable, there's a risk the unit may become unstable, leading to excessive vibration, noise, and potential water spillage.

Product overview

Front view

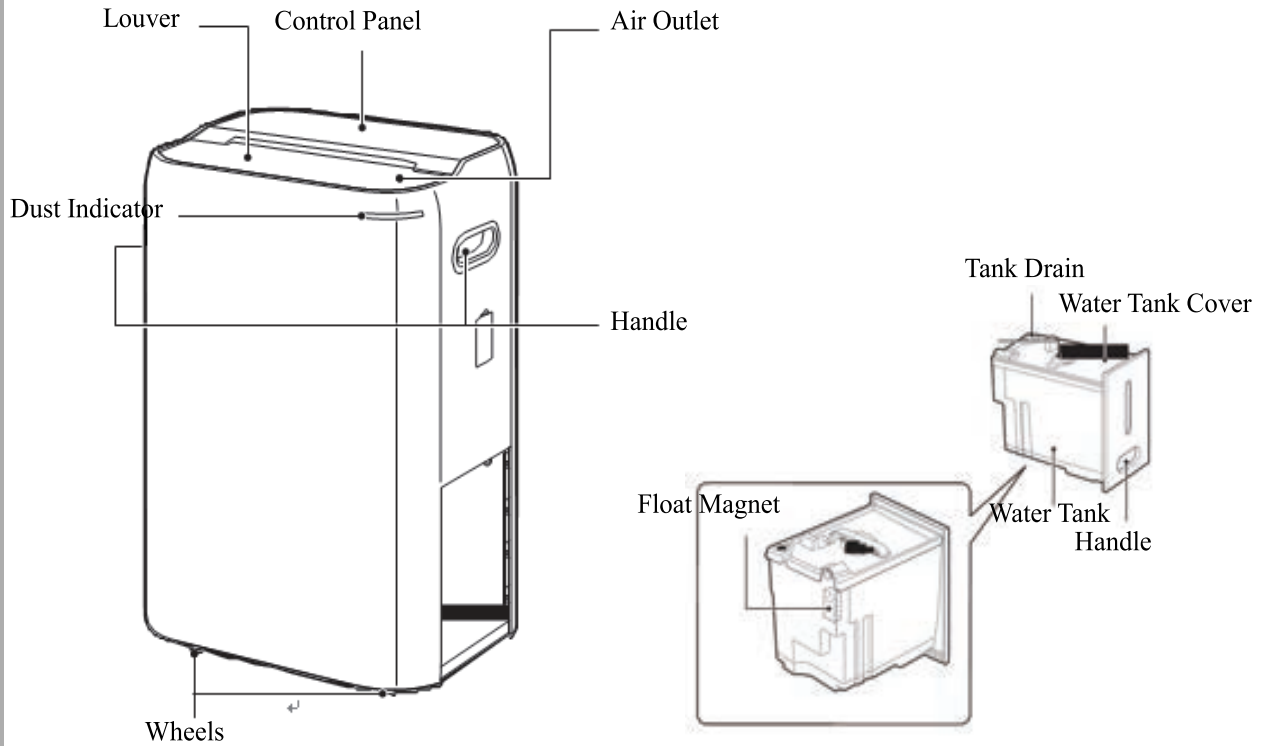

Back view

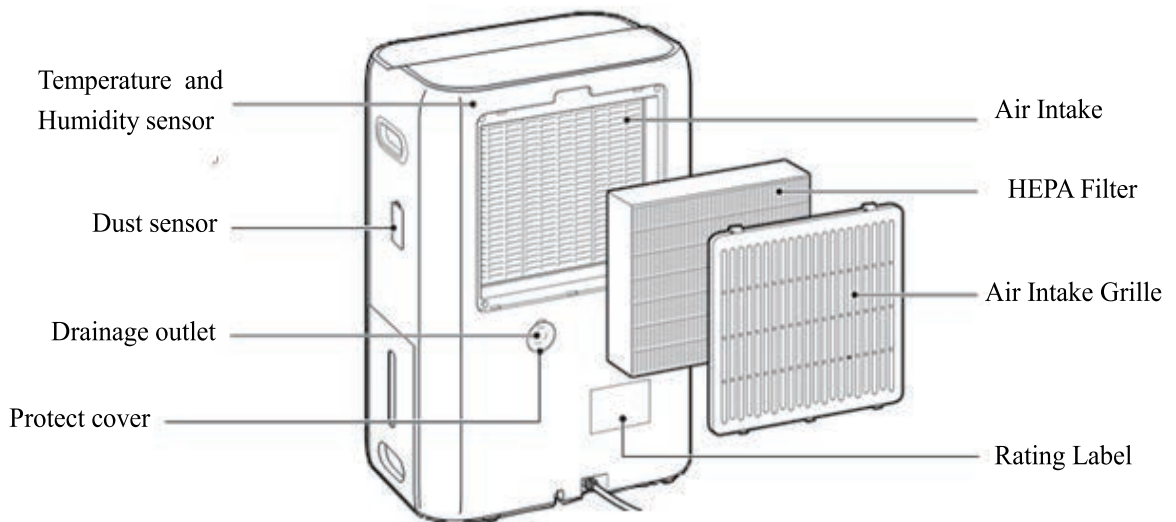

Air Outlet

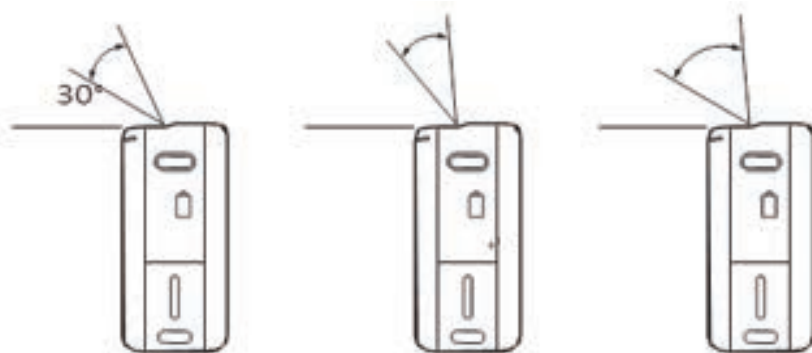
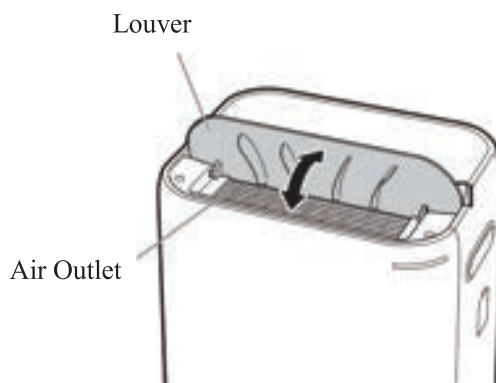
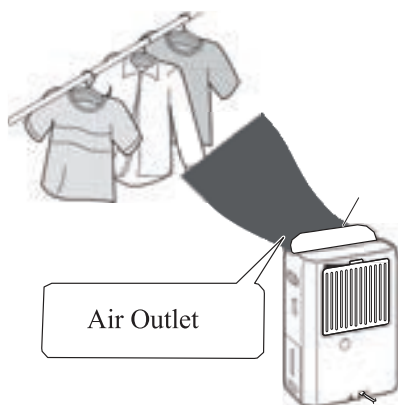

Front swing wind Back swing wind Wide area swing









Operating Introduction

(1) Control Panel







(2) Functions & Name of Key Pads

1.  Power (On/Off): Switch on/off the power

2.  (Mode): Press the button to select Continuous dehumidification / Automatic dehumidification / Laundry /Air purifier.
3.  (Speed): Press the button to set the air speed settings (Low/High/Auto).
4.  (Swing): Press the button to setting the swing range of the outlet (front / back /wide area)
5.  (Humidity/Timer set): Press the button to configure the humidity performance ranges. (RH40%---RH70%) or scheduled time setting (0 hours to 12 hours)
6.  (Timer/Child Lock): Set the turn-off time (0h-12h). Press and hold for 2 seconds to activate or deactivate the child lock.
7.  (Inner dry): Press the button to set the inner dry close or open. Press and hold for 2 seconds to booked the inner dry.
8.  Defrost : Machine will light up the indicator when defrost function is running.
9.  Water Full: Machine will light up the indicator when water tank is full of water.

(3) Set the 12-hour auto shutdown function

The machine activates the 12-hour auto shutdown function by default, and will automatically shut down after 12 hours of continuous operation (during the 12-hour timing process, each time the button is touched, the timer will be reset for 12 hours); If you need the machine to run continuously, please change the settings:

1. When the machine is in standby mode, press and hold  +  for 2 seconds at the same time. The buzzer will 'beep' once and the machine will enter the "auto shutdown" setting mode;
2. Touch  to switch between enabling or disabling the "Auto Shutdown" function.
 - When "Auto Shutdown" is activated, the "Reservation" indicator flashes;
 - When "Auto Shutdown" is turned off, the "Drying" indicator flashes;
3. Touch the  button and the buzzer will beep once. The internal drying indicator light will light up for 3 seconds and then go out. This completes the 12-hour auto shutdown "on" or "off" function setting.
 - During the process of changing settings, if the  button is not touched, the settings will not be saved.

(4) Indicator Description:

When the water tank is full, the indicator light is on (red) colour , otherwise it is off.

Dust Indicator

The dust indicator light displays in five colors based on the amount of dust: light blue, green, yellow, orange, and red light notification.

Light Blue	Green	Yellow	Orange	Red
Excellent	Good	Moderate	Bad	Worst

During the first minute of operation, no matter whether the air if it is dirty, the light blue light will turn on.

Water tank:

Wash it with water about once a month, or when you are concerned about odor or dirt.

1. Remove the water tank from the unit.	
2. Please pull up both sides of the cover and remove water tank cover.	
3. Clean the water tank and water tank cover with water. - If there is hard-to-remove dirt, use a soft brush and diluted neutral kitchen detergent Wash and rinse the dish soap thoroughly to avoid residue.	
4. Install the water tank upper cover to the water tank. Please install securely to avoid gaps. CAUTION: Operation without the water tank upper cover may cause internal water overflows and wets furniture, etc.	
5. Install the water tank to the unit. When the float magnet falls off, please install it back to its original position according to the magnet position and direction as shown in the figure. • Please confirm whether there are foreign objects or impurities mixed in the float magnet. Otherwise, it will not be possible to detect the test water is full, causing water to overflow. • Never remove the float magnet. Be sure to reinstall it if it comes off.	

When the defrosting function is working, this indicator light is on (white)color, otherwise it is off.

(5) Cleaning the Unit:

- Clean the unit using a damp sponge and dry it with a clean, soft cloth.
- Avoid using alcohol or products containing solvents.
- Do not immerse the unit in water.

(6) Cleaning the Air Intake Grille:

The function of the air intake grille is to filter dust and impurities in the air. If the air intake grille is blocked by dust, it will affect the performance and consume higher energy, and may cause the machine overheat and fire. Therefore, under normal usage, it is recommended to clean the air intake grille once every two weeks to maintain good dehumidification capabilities.

Remove the air intake grille

Pull the upper end of the air intake grille forward and lift it up to remove it.



Install the air intake grille

Insert the latches (3 places) under the air intake grille into the machine. Then press it directly into the machine to install. Please be sure to insert the upper and lower latches into the holes of the machine.

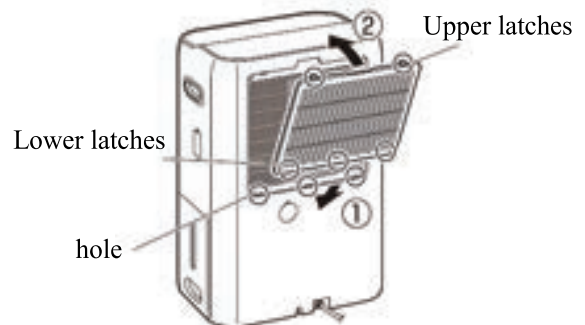

After vacuuming up the dust, remove it, wash it and place it in a dry place to dry thoroughly.

- If it is heavily soiled, please clean it with a soft brush and neutral kitchen detergent. Rinse the detergent thoroughly to avoid residue, and then place it in a dry place to dry thoroughly.

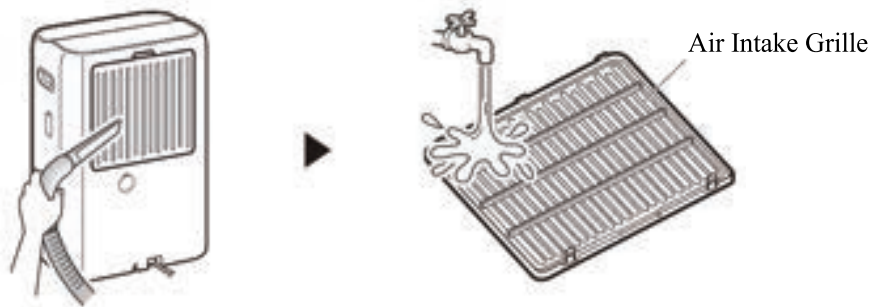

(7) HEPA Filter (Filter Model: RPD-Y/HEPA):

HEPA filter replace approximately every 1 year.

- Do not clean with vacuum cleaner or wash with water.
- When the filter is damaged and has holes, dust will pass through the filter, resulting in reduced dust collection performance.
- In places with dirty air when used, replacement frequency will be shortened. Replace when it begins to lose effectiveness.

Replace the HEPA filter

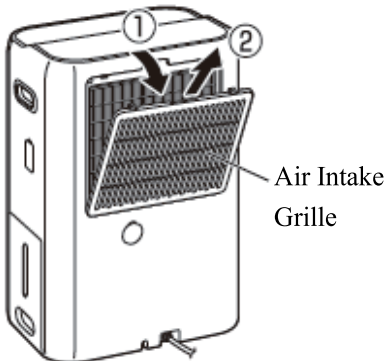
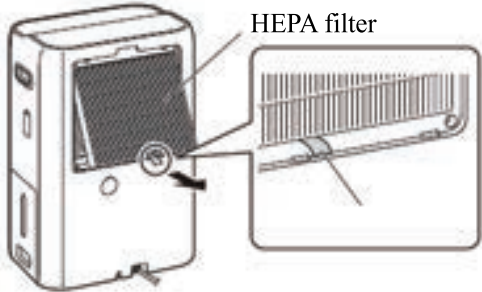
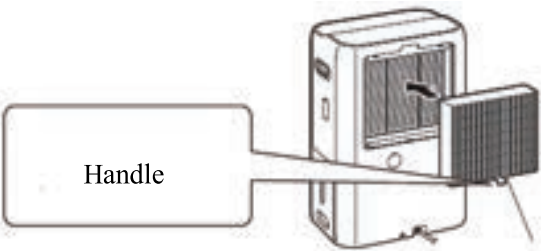
<p>1. Remove the air intake grille.</p> <ul style="list-style-type: none"> • Pull the upper end of the air intake grille forward and then lift it up to remove it. 	<p>2. Remove the HEPA filter.</p> <ul style="list-style-type: none"> • Pull the small handle under the HEPA filter and pull it forward to remove it. 
<p>3. Install a new HEPA filter.</p> 	<p>4. Record the year/month in which it was used.</p>

(8) Dust Sensor:

Dust sensor lens wipe approximately once every 3 months.

1. Remove the sensor air inlet cover.
2. Please use a dry cotton swab to gently wipe along the left side of the interior.
3. Please use the slit nozzle of a vacuum cleaner to remove the surrounding dust.
4. Make sure to put the lid on. (Otherwise it will cause incorrect operation)

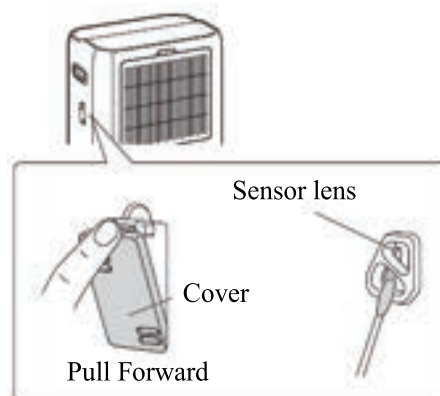

Continuous Drainage Function

When the dehumidifier needs continuous drainage, pull out the drain hole plug, connect the drain hose* with 12mm inner diameter to the drain outlet on the rear case. When the dehumidifier runs continuously, the water will drain out through drainage hose, then water tank will not contain the water, the machine can work continuously and does not shut down due to full water tank.

During continuous water draining, the drainage hose has to place flatly on the ground. The drain hose cannot be curved or cocked, otherwise, the water cannot flow out smoothly or even cannot flow.

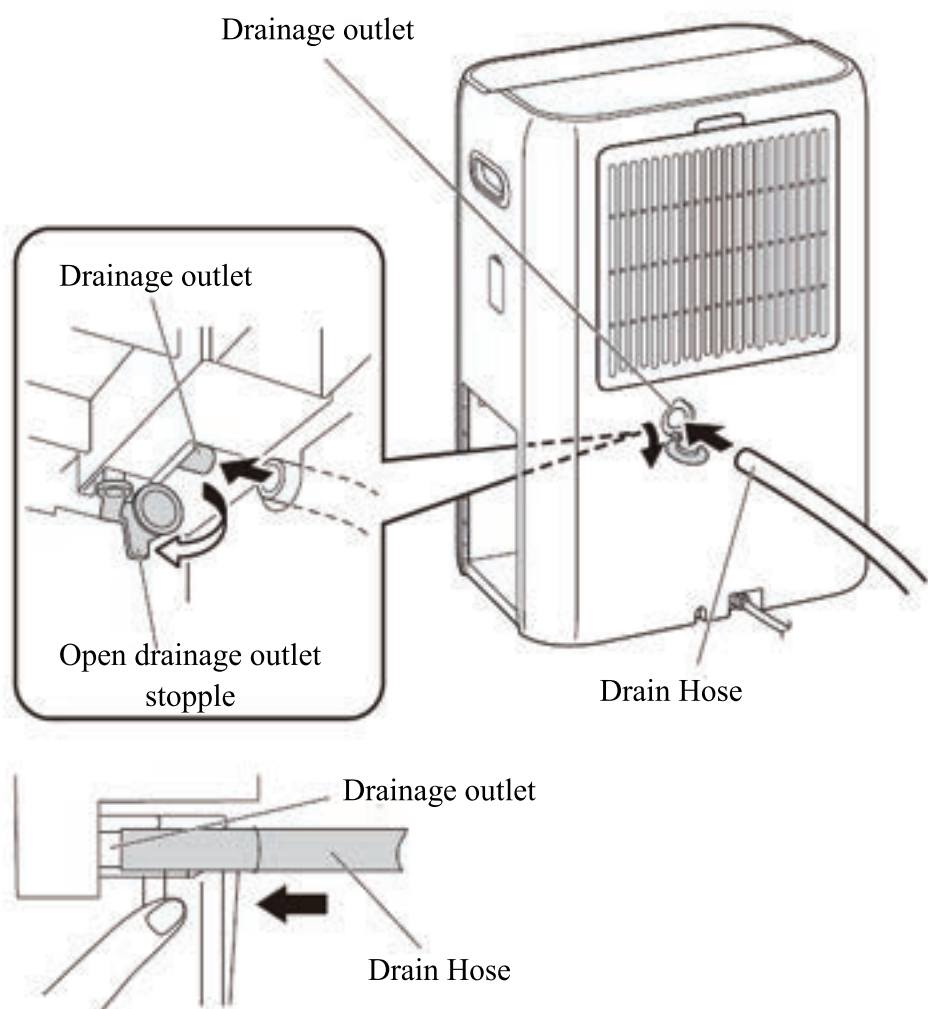

*Drain hose needs to be purchased by yourself.

Error codes

Parts	Conditions	Error codes
Photoelectric tipping switch	unit tilt 45°	A0
Ambient temperature sensor NTC	Ambient temperature $\leq 0^{\circ}\text{C}/\geq 40^{\circ}\text{C}$	C9
Humidity sensor	Open cut	Lo
Humidity sensor	Short cut	Hi
Defrost temperature sensor	Open cut/Short cut	C4
NTC	NTC $\geq 40^{\circ}\text{C}$	C4
Refrigerant leakage	Refrigerant leakage	U0
Motor main fan	Motor blocked/ open circuit	A6

Trouble Shooting

Check the following before contacting technical support:

Problem	Checklist
The unit does not work	<ul style="list-style-type: none"> <input type="checkbox"/> Ensure the power plug is fully inserted into the socket. <input type="checkbox"/> Check whether the dehumidifier has reached its preset level, or the bucket is full. <input type="checkbox"/> Verify that the water bucket is positioned correctly.
Poor dehumidifying performance	<ul style="list-style-type: none"> <input type="checkbox"/> Ensure the unit has operated for a sufficient duration to remove moisture. <input type="checkbox"/> Check for obstacles blocking the air inlet or outlet. <input type="checkbox"/> The ambient humidity might be lower than the set humidity level. <input type="checkbox"/> Ensure all doors, windows, and other openings are securely closed. <input type="checkbox"/> Room temperature may be too low, below 5°C (41°F).
Excessive noise	<ul style="list-style-type: none"> <input type="checkbox"/> Ensure the unit is placed on a stable, flat surface. <input type="checkbox"/> Clean the Air Intake Grille regularly.

If the above solutions cannot fix the problem, stop using immediately and contact Shun Hing Electric Service Centre Ltd to check and repair.

Specifications

Model	RPD-Y25HC
Rated voltage and frequency	220-240V~ 50Hz
Dehumidifier capacity	25L/D(30°C,80%RH); 14.5L/D(26.7°C,60%RH)
Consumed power	260W(26.7°C,60%RH);
Refrigerant	R290 (95g)
Water tank capacity	3.7 L
Product dimensions (W x D x H)	376 x 271 x 578 mm
Weight	14.6 kg

Special Avowal

1. The information above has been checked. Our company reserves the hermeneutic power to any printing errors or misunderstanding on the content.
2. If there are technical improvements on the appliance, the instruction manual will be updated without any prior notice. The product appearance and color are subject to the actual appliance.
3. An electronic copy of the instruction manual can be emailed to the customer on requested. If necessary, please call Shun Hing Electric Works & Engineering Co., Ltd.: 2861 2767.

After Sales Service

For any defect, in the judgment of technician from Shun Hing Electric Service Centre Limited, caused under normal use, we are responsible for repairing or replacing parts of the said electrical appliance free of charge within one year guarantee period commencing from the date of purchase. Any defective part which has been replaced shall become our property. Guarantee service does not cover the repair or replacement of accessories, external cables, water tank or cabinet, etc. Additional charges shall be levied if services are required.

Please present the official invoice and the guarantee certificate with the sales point's chop or the redemption center's chop for free maintenance. For enquiries, please call Shun Hing Electric Service Centre Limited hotline at 2406 5666.

Free guarantee service will not be provided to the unit if: 1) it has been explicitly or implicitly modified, tampered with, altered or repaired in any way by persons other than technicians of the Company. Or 2) it has been damaged through misuse, negligence, liquid ingress or corrosion, power interruption, natural calamities or accident or external factors. Or 3) it is not a fixed installation on land. Or 4) the normal operation of the unit is affected by improper installation. Or 5) the domestic model of unit is used for industrial or commercial purpose. Or 6) the change of location or ownership of the unit and did not inform Shun Hing Electric Service Centre Limited.



信興電工工程有限公司

SHUN HING ELECTRIC WORKS & ENGINEERING CO., LTD

辦公室: 香港九龍尖沙咀東部麼地道 67 號半島中心 9 樓

OFFICE: 9/F, PENINSULA CENTRE, 67 MODY ROAD, TSIMSHATSUI EAST, KOWLOON, HONG KONG

電話 TEL: (852) 2861 2767 傳真 FAX: (852) 2865 6706

網址 WEBSITE: www.rasonic.hk 電郵 EMAIL: shew@shunhinggroup.com

保養及維修 MAINTENANCE AND REPAIR SERVICE

信興電器服務中心有限公司

SHUN HING ELECTRIC SERVICE CENTRE LTD.

辦公室: 香港新界葵涌勝耀街 2 號信興中心 11 樓

OFFICE: 11TH FLOOR, SHUN HING CENTRE, 2 SHING YIU STREET, KWAI CHUNG, NEW TERRITORIES, HONG KONG

電話 TEL: (852) 2406 5666

傳真 FAX: (852) 2408 0316

網址 WEBSITE: www.shesc.com

消耗品/附件銷售熱線 CONSUMABLES/ ACCESSORIES SALES HOTLINE

電話 TEL: (852) 2406 5666

客戶服務中心 CUSTOMER SERVICE CENTRES

香港新界葵涌勝耀街 2 號信興中心 1 樓

1ST FLOOR, SHUN HING CENTRE, 2 SHING YIU STREET, KWAI CHUNG, NEW TERRITORIES, HONG KONG

電話 TEL: (852) 2406 5439

傳真 FAX: (852) 2408 1389

澳門慕拉士大馬路 193-199 號南嶺工業大廈 5 樓 I 座

AVENIDA DE VENCESLAU DE MORAIS, NO. 193-199, 5 ANDAR-I, EDF. INDUSTRIAL NAM LENG, MACAU

電話 TEL: (853) 2836 2928

傳真 FAX: (853) 2833 6405

有關最新之客戶服務中心資訊, 請參閱信興服務中心網址 www.shesc.com 或致電維修服務熱線查詢。
For the latest information of customer service centres, please visit www.shesc.com or call us at our hotline.