

## 4.1.2 RS-RE18UK RS-RE24UK

<Top View>

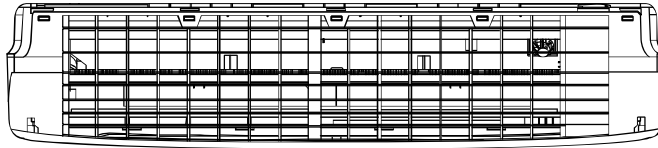

<Side View>

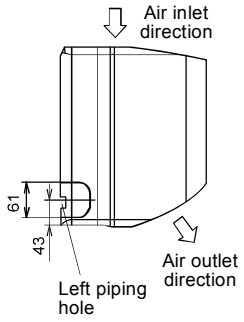

<Front View>

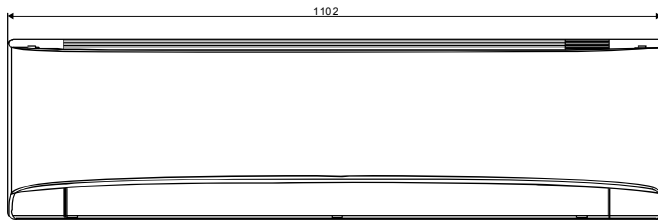

<Side View>

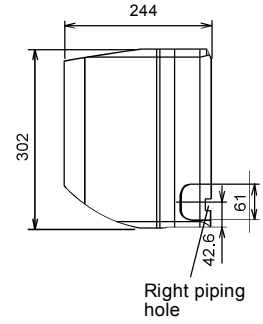

<Bottom View>

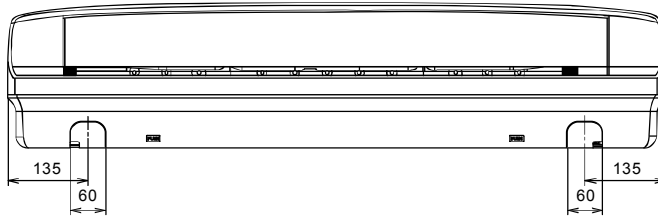

<Remote Control>

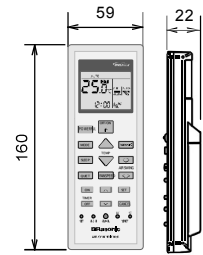

<Rear View>

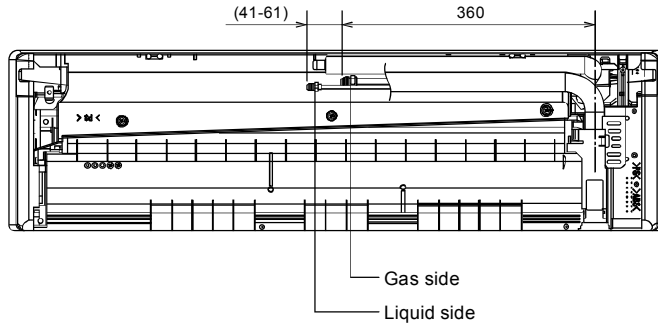

<Remote Control Holder>

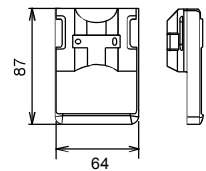

Relative position between the indoor unit and the installation plate <Front View>

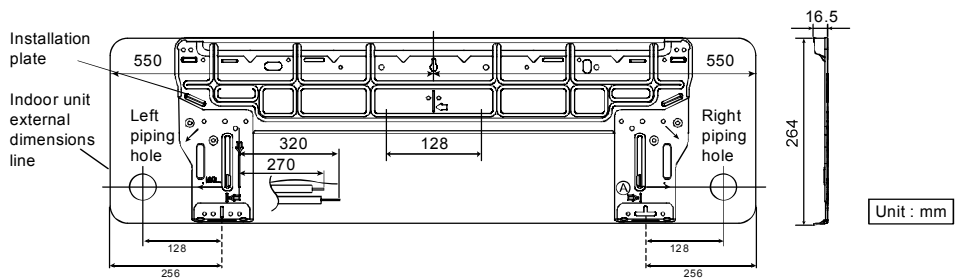

## 4.2 Outdoor Unit

### 4.2.1 RU-RE9UK RU-RE12UK

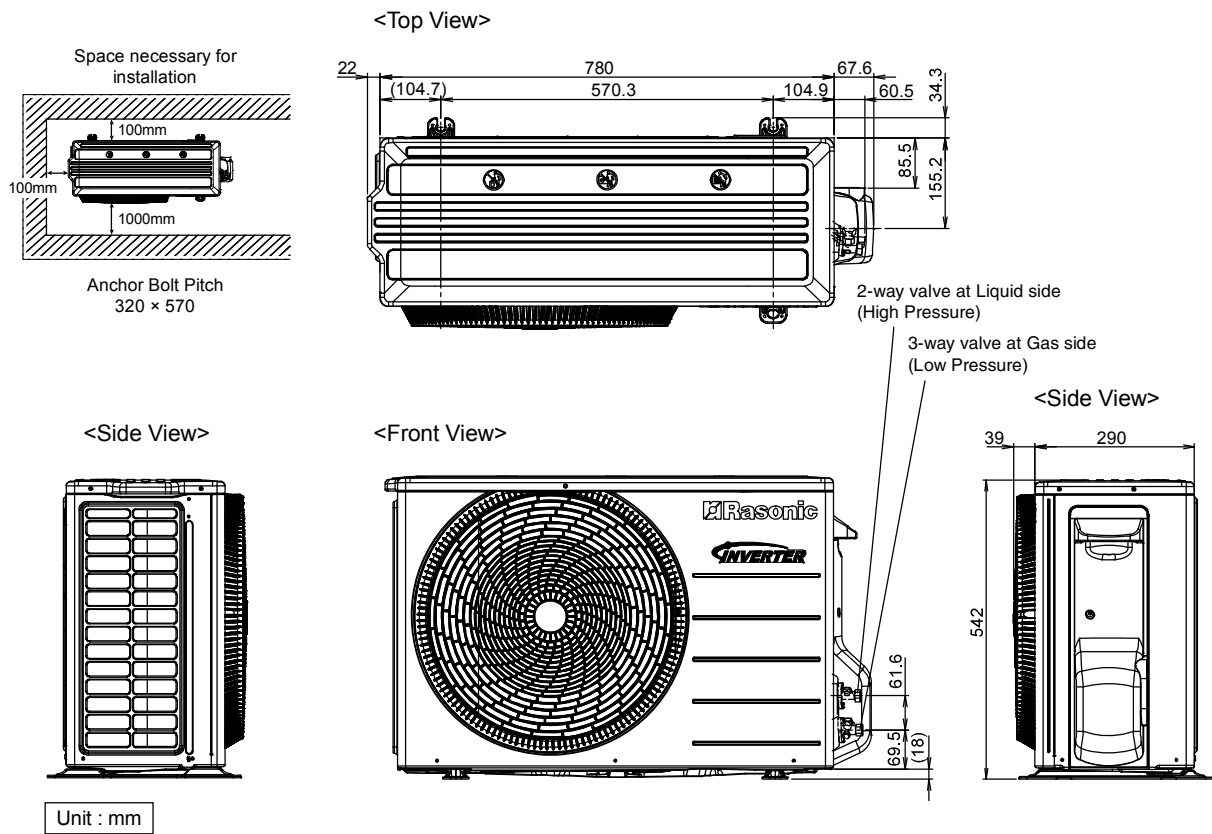

### 4.2.2 RU-RE18UK

